

PROJECT MANUAL FOR
**Wildwood Park Mountain Bike Trails, Skills
Park, and Pump Track**



RECREATION AND PARKS

Greenville Recreation and Parks
2000 Cedar Ln
Greenville, NC 27858
252-329-4567

Project Designer
Nature Trails LLC
11312 US 15 501 N Ste 107185
Chapel Hill, NC 27517
(919) 960 1559

April 8, 2022

100 % CONSTRUCTION DOCUMENTS

**Wildwood Park Mountain Bike Trails,
Skills Park, and Pump Track
GREENVILLE, NORTH
CAROLINA**

**CONTRACT AND SPECIFICATIONS
CITY OF GREENVILLE, NORTH CAROLINA**

MAYOR: P. J. CONNELLY

COUNCIL MEMBERS:
ROSE H. GLOVER
BRIAN MEYERHOEFFER
MONICA DANIELS
WILL BELL
RICK SMILEY
WILL LITCHFIELD

CITY MANAGER: ANN E. WALL

CITY ATTORNEY: EMANUEL D. MCGIRT

CITY CLERK: VALERIE SHIUWEGAR

Project Contact: Mark Nottingham, AICP
mnottingham@greenvillenc.gov

TABLE OF CONTENTS

PART I – BIDDING AND CONTRACT DOCUMENTS

ADVERTISEMENT FOR BIDS

INSTRUCTION TO BIDDERS (**PLEASE READ**)

PROPOSAL FORM (**USE THIS FORM ONLY**)

BID BOND FOR THE CITY OF GREENVILLE (**USE THIS FORM ONLY, If bid is over \$500k**)

PERFORMANCE AND PAYMENT BOND FOR THE CITY OF GREENVILLE (**USE THIS FORM ONLY**)

CITY OF GREENVILLE/GREENVILLE UTILITIES COMMISSION MINORITY AND/OR
WOMEN BUSINESS ENTERPRISE (M/WBE) PROGRAM

PART II – CONSTRUCTION SPECIFICATIONS

GENERAL CONDITIONS

CONSTRUCTION DOCUMENTS (TRAIL PLAN)

PART I

BIDDING REQUIREMENTS

ADVERTISEMENT FOR BIDS

The Greenville Recreation and Parks Department (GRPD) will accept bids for the Wildwood Park Mountain Bike Trails, Skills Park, and Pump Track construction project. **SEALED, SINGLEPRIME BIDS** from qualified bidders will be received by the City in the offices of Recreation and Parks, 2000 Cedar Ln. Greenville, NC 27858, **at 2:00 pm (Eastern Standard Time) on April 20, 2022, and publicly opened thereafter at 2:01 pm.** Bids shall be marked "SEALED BID", addressed to the attention of Mr. Mark Nottingham, Greenville Recreation and Parks Department, and shall include the Name, Address, and License Number of the bidder, and the type proposal enclosed.

Each bidder must show evidence that they are licensed under Chapter 87 of the N.C. General Statutes. Performance and payment bonds are required.

General Description of the work:

The work includes all labor, equipment, and materials to complete in every detail of the work indicated on the plans and specifications. Specifically, all work incidental thereto Wildwood Park Mountain Bike Trails, Skills Park, and Pump Track including, but not limited to, demolition, earthwork, construction, drainage, paving improvements, and plantings.

MBE/WBE PARTICIPATION

The goal for Minority and / or Women Business Enterprise (M/WBE) participation is MBE 10% and WBE 6%. Each goal must be met separately. Exceeding one goal does not satisfy requirements for the other.

CONTRACT DOCUMENTS

Copies of the CONTRACT DOCUMENTS may be obtained electronically via the City of Greenville Current Bid Opportunities Webpage. For information, contact MarkNottingham at 252-329-4242 or mnottingham@greenvillenc.gov.

If applicable, each proposal shall be accompanied by a bid bond executed by a corporate security licensed to do so under North Carolina law, of an amount equal to not less than five percent (5%) of the proposal, or in lieu thereof, a bidder may offer a certified check on a bank or trust company insured by the Federal Deposit Insurance Corporation. Each bidder's deposit, except for the bidder to whom the contract is awarded, shall be returned after the contract awarded. The City shall retain the bid deposit of the bidder to whom the contract is awarded if the bidder fails to execute the contract within ten days after the award.

To whom the contract is awarded, a Performance and Payment Bond will be required for one hundred percent (100%) of the contract price.

No bid may be withdrawn after the scheduled closing time for the receipt of bids for a period of 60 days after the bid date.

The City Council of the City of Greenville reserves the right to reject any or all proposals.

SIGNED:

Mark Nottingham
City of Greenville Recreation and Parks Department 2000 Cedar Lane
Greenville, NC 27858

INSTRUCTIONS TO BIDDERS

1. Bids will be received for Single Prime Contract. All proposals shall be for lump sum. It is the intent of the City to award this bid to the lowest responsive and responsible bidder.
2. Bidders are requested to return bids to the City of Greenville Recreation and Parks Department prior to bid opening. Bids will be opened promptly at the time specified in the Invitation to Bid. Bidders are cautioned to be prompt since No Bids Will Be Accepted after the time designated for the bid opening. The precise time will be monitored by the by the person responsible for opening the bids.
3. All bids submitted must be on the blank proposal forms herein provided and prices given shall be both in writing and figures and the complete form shall be without any lineation, alterations, or erasures. In case of conflicting prices, the written prices shall govern.
4. Bids shall be enclosed in a sealed envelope, directed to the City of Greenville, Recreation and Parks Department, 2000 Cedar Lane, Greenville, North Carolina 27858, and marked with the bidder's North Carolina Contractor's License number. All bids must be marked Bid on the outside of the envelope.
5. Each proposal shall contain the full name and address of each bidder. When firms bid, the name of each member shall be signed and the firm name added, and the execution shall be done as more specifically stated herein under the following section.
6. The omission of prices upon any item for which bids are asked or the tendering of an unbalanced bid will be the cause of the rejection of the bid submitted.
7. No bid shall be considered or accepted by the City unless at the time of its filing, it is accompanied by a deposit of cash, or a cashier's check, or a certified check on some bank or trust company insured by the Federal Deposit Insurance Corporation in an amount equal to not less than five percent (5%) of the bid, if applicable. In lieu of making that deposit, the bidder may file a bid bond executed by a corporate surety licensed under the laws of North Carolina to execute such bonds, conditioned that the surety will upon demand forthwith make payment to the City of Greenville upon the bond if the bidder fails to execute the contract in accordance with the bid bond. This deposit shall be retained by the City if the successful bidder fails to execute the contract within 10days after the award or fails to give satisfactory bonds or deposit as required herein. The bidder towhom the award of contract is made shall either (a) furnish bonds as required by Article 3 of Chapter 44A of the N.C. General Statutes, using the form supplied by the City; or (b) deposit withthe City money, certified check or government securities. The bonds or deposit shall be for the full amount of the contract to secure the faithful performance of the terms of the contract and the payment of all sums due for labor and materials in a manner consistent with Article 3 of Chapter 44 AINSTRUCTIONS TO BIDDERS
8. General Contractors are notified that Chapter 87, Article 1, General Statutes of North Carolina will be observed in receiving and awarding general contracts. General contractors submitting bids on this project must have license classification for general contractor.

NOTE: Under GS 87-1, a contractor that superintends or manages construction of any building, highway, public utility, grading, structure, or improvement shall be deemed a "general contractor" and shall be so licensed. Therefore, a single prime project that involves other trades will require the single prime contractor to hold a proper General Contractors license.

9. Except to the extent allowed by statute, bids shall not be withdrawn, and bids shall remain subject to acceptance by the City for a period of 90 days.

10. Bidders must present satisfactory evidence that they have been regularly engaged in the business of constructing such work, and that they are fully prepared with the necessary capital, equipment, etc., to begin the work promptly, and complete the same in accordance with specifications. Bidder must meet Qualified Trail Contractor requirements found in the Construction Specifications.
11. The bids will be evaluated, and the contract awarded in accordance with statutory public contract requirements as supplemented or altered by the Minority and / or Women Business Enterprise (M/WBE) requirements supplied with this bid package. These forms must be filled out and returned with the bid proposal. Any bids submitted without these completed forms shall be deemed as “non-responsive”. If there are any questions or problems in filling out these forms, please contact:
Angelene Brinkley, Interim Financial Services Manager (252) 329-4862
12. The successful bidder is required to commence work within ten (10) written days after written notice from the Project Manager. Termination of work shall also be controlled by the City of Greenville.
13. The contractor will furnish all materials, labor, equipment, supervision, tools, machinery, etc. for complete construction of projects in accordance with plans and specifications of the City of Greenville.
14. The bidder to whom the award is made shall be required to furnish work crews of adequate number, size, and experience to properly perform the work. The interpretation of the number of crews, size, and experience will be determined by the City of Greenville as to their adequacy.
15. It shall be the contractor’s responsibility to obtain all necessary and required permits and inspections. These permits shall be presented upon demand.
16. The Contractor will perform, or have performed, all necessary site layout (both lines and grades)for this construction.
17. The Contractor must provide the City of Greenville a safety plan of their organization, prior to approval of the contract
18. The contractor(s) to whom the award is made must carry insurance in the amounts and types outlined in the Insurance Requirements section of this document.
19. The insurance herein required shall be with an insurance company authorized to do business in North Carolina and having a BEST rating of A or better.
20. Insurance shall be evidenced by a certificate:
 - Providing notice to the City of not less than 30 days prior to cancellation or reduction of coverage
 - Certificates should be addressed to:
City of Greenville, North Carolina
Attn: Mark Nottingham
2000 Cedar Ln
Greenville, NC 27858

Insurance

The Company agrees to purchase at its own expense insurance coverages to satisfy the following minimum requirements. A certificate reflecting the following minimum coverages shall accompany this Agreement:

Workers' Compensation Insurance:

Limits:

Workers Compensation: Statutory for the State of North Carolina

Employers Liability: Bodily Injury by Accident \$1,000,000 each accident

Bodily Injury by Disease \$1,000,000 policy limit

Bodily Injury by Disease \$1,000,000 each employee.

No sub-contractor may exclude executive officers. Workers Compensation must include all employees.

Commercial General Liability:

Limits:

Each Occurrence:	\$1,000,000
Personal and Advertising Injury	\$1,000,000
General Aggregate Limit	\$2,000,000
Products and Completed Operations Aggregate	\$2,000,000

The aggregate limit must apply per project. The form of coverage must be the ISO CG 00 01 policy as approved by the State of North Carolina Department of Insurance. If a form of coverage other than the CG 00 01 is used it must be approved by the City. Any endorsed exclusions or limitations from the standard policy must be clearly stated in writing and attached to the Certificate of Insurance. Completed Operations coverage must be maintained for the period of the applicable statute of limitations.

The City must be added as an Additional Insured to the Commercial General Liability policy.

Commercial Automobile Liability:

Limits:

\$1,000,000 combined single limit.

The City must be added as an Additional Insured on the Commercial Auto Liability policy.

All insurance companies must be admitted to do business in North Carolina and be acceptable to the City. If the insurance company(s) is a permitted surplus lines insurer, the insurance company name, and NAIC number must be submitted to the City's Risk Manager for approval before commencing work. Company shall be required to provide the City no less than thirty (30) days' notice of cancellation, or any material change, to any insurance coverage required by this

Agreement.

A Certificate of Insurance (COI) must be issued by an authorized representative of the insurance carrier(s). Certificates of Insurance must have the Insurance Company name and NAIC number clearly identified.

The City's review or acceptance of Certificates of Insurance shall not relieve the Company of any requirement to provide the specific insurance coverages set forth in the Agreement. Nor shall the City's review or acceptance of Certificates of Insurance constitute a waiver of the specific insurance coverage requirements set forth in the Agreement or acknowledgement that all insurance coverage requirements set forth in the Agreement have been met.

21. The traditional certificate form will remain as evidence of insurance coverage, but this will no longer suffice to document that the City is an additional insured, even if the certificate so states. In order to comply with the with the additional insured requirements, contractors will need to carry one of two types of additional insured endorsements to the policy:

- Option 1 - A specific additional insured endorsement to make the City of Greenville, NC an additional insured for the purpose of the contract, or
- Option 2 - A blanket additional insured endorsement to cover all companies (including the City of Greenville, NC) that require additional insured protection.

If a contractor chooses Option 1, the specific endorsement, the required documentation for City Contracts is:

- A certificate of insurance to document the coverage, plus
- An **original** of the endorsement to effect the additional coverage.

If a contractor chooses Option 2, the blanket endorsement, the required documentation for City Contracts is:

- A certificate of insurance to document the coverage, plus
- Statements by the agent on the certificate of insurance that:
 - The general liability policy includes a blanket additional insured endorsement showing the endorsement form number, and
 - The City is an additional insured.

22. Indemnification.

- a) To the maximum extent allowed by law, Contractor shall indemnify and save harmless indemnities from and against all charges that arise in any manner from, in connection with, or out of this contract (including, but not limited to, charges that arise as a result of acts or omissions of Contractor, Indemnities, or any other person, firm or corporation). In performing its duties under this subsection "a", Contractor shall at its sole expense defend Indemnities with legal counsel reasonably acceptable to the City of Greenville ("City").
- b) Definitions. As used in subsections "a" above and "c" below – "Charges" means claims, judgments, costs, damages, losses, demands, liabilities, obligations, fines, penalties, royalties, and expenses (including interest and reasonable attorney's fees assessed as part of any such item); "Contractor" means all parties to this contract other than City; and "Indemnities" means City and its officers, officials, independent contractors, agents, and employees.
- c) Limitation of Contractor's Obligation. If this is in, or is in connection with, a contract relative to the design, planning, construction, alteration, repair or maintenance of a building, structure, highway, road appurtenance or appliance, including moving, demolition and excavating therewith, then subsection "a" above shall not require the Contractor to indemnify or hold harmless the City, its independent contractors, agents, employees, or indemnities against liability for damages arising out of bodily injury to

persons or damage to property proximity caused by or resulting from the negligence, in whole or in part, or the City, its independent contractors, agents, employees, or indemnities.

23. Hold Harmless and Indemnity Agreement:

To the fullest extent permitted by law, Company shall indemnify and hold harmless the City, its employees, agents, and consultants against any liability arising out of or in connection with any of the operations or obligations of Company, including but not limited to any said operations or obligations subcontracted or assigned to a different person or entity from claims, damages, losses, and expenses, including but not limited to attorneys' fees, which is attributable to bodily injury, sickness, disease or death, or to injury to or destruction of tangible property, caused by acts or omissions of Company or anyone directly or indirectly employed by them or anyone for whose acts the Company may be liable, regardless of whether or not such claim, damage, loss or expense is caused in part by a party indemnified hereunder. Such obligation shall not be construed to negate, abridge, or reduce other rights or obligation of indemnity which would otherwise exists as to a party or person described in this paragraph.

24. The successful bidder is required to commence work within ten (10) written days after written notice from the Project Manager. Termination of work shall also be controlled by the City of Greenville.

25. All work under this contract shall be completed within three hundred and sixty five (365) days from the date of the Notice to Proceed.

26. E-VERIFY COMPLIANCE: The Contractor shall comply with the requirements of Article 2 of Chapter 64 of the North Carolina General Statutes. Further, if the Contractor utilizes a Subcontractor, the Contractor shall require the Subcontractor to comply with the requirements of Article 2 of Chapter 64 of the North Carolina General Statutes. By submitting a proposal, The Proposer represents that their firm and its Subcontractors are in compliance with the requirements of Article 2 Chapter 64 of the North Carolina General Statutes.

27. IRAN DIVESTMENT ACT: Vendor certifies that: (i) it is not on the Iran Final Divestment List created by the NC State treasurer pursuant to N.C.G.S. 147-86.58; (ii) it will not take any actions causing it to appear on said list during the term of any contract with the City, and (iii) it will not utilize any subcontractor to provide goods and services hereunder that is identified on said list.

28. Any questions regarding the Contract Conditions and Bid Documents should be directed to Mark Nottingham in writing by email to mnottingham@greenvillenc.gov .

(USE THIS FORM ONLY)

SUBMIT PROPOSALS IN CARE OF:
Recreation and Parks Department City of Greenville
2000 Cedar Lane
Greenville, NC 27858
(252) 329-4242

BIDDER'S FIRM NAME: _____

DATE: April 20, 2022

PROPOSAL: Wildwood Park Mountain Bike Trails, Skills Course, and Pump Track
The Undersigned, as Bidder, hereby declares that only person or persons interested in this proposal as principals or principals is or are named herein and that no other persons than herein mentioned has any interest in this proposal or in the contract to be entered, that this proposal is made without connection with any other person, company or parties making a bid or proposal; and that it is in all respect fair and in good faith without collusion or fraud.

The bidder further declares that he has examined the site of the work and informed himself fully in regard to all conditions pertaining to the place where the work is to be done; that he has examined the specifications for the work and the contract documents relative thereto, and has read all special provisions furnished prior to the opening of bids, that he has satisfied himself relative to the work to be performed.

Materials to be furnished shall be in compliance with standard specifications and special provisions. CONTRACTOR'S responsibility shall continue uninterrupted until expiration of the warranty period as stated in the specifications after completion of the work. The owner (City of Greenville) reserves the right to select any or all of the alternates and to increase or decrease the total contract amount utilizing the unit prices supplied by the CONTRACTOR in the bid form.

The Bidder agrees, if his proposal is accepted, to contract with the City of Greenville, 200 West Fifth Street, Greenville, NC 27858, in the form of contract specified, to furnish all necessary materials, equipment, machinery, tools, apparatus, means of transportation, and labor necessary to complete within the time allotted as specified, the General Construction work on the Owner's property, in complete accordance with the Plans, Specifications, and Contract Documents bearing the title **Wildwood Park Mountain Bike Trails, Skills Park, and Pump Track** with a definite understanding that no money will be allowed for extra work except as set forth in the Contract Documents for the sums as follows.

**City of Greenville, NC
Wildwood Park Mountain Bike
Trails, Skills Park, and Pump Track
BID FORM**

Wildwood Park Bid Sheet

Item No	Description	Est Quantity	Unit
Miscellaneous			
1	Mobilization	1	LS
		Sub Total	\$
Singletrack Trail Construction			
1	USFS Class 3, Bike Optimized Singletrack Trail (36" average width)	31,700	LF
2	Boardwalk without handrail (615ft x 3ft)	1,845	SQ FT
3	Traction enhancement for boardwalk decking	1845	SQ FT
4	Imported 4" Thick Stone Trail Armoring	144	TN
		Sub Total	\$
Pump Track Construction			
1	Site Preparation + Drainage	1	LS
2	70/30 Clay/Sand Fill Material	875	CU YD
3	Road Base Fill	80	CU YD
4	Paved Riding Surface	3,958	SQ FT
		Sub Total	\$
Skills Park Construction			
1	40' Shipping Container with flood vents, anchors	2	LS
2	20' Shipping Container with flood vents, anchors	1	LS
3	70/30 Clay/Sand Fill Material	1200	CU YD
4	Start area, container surfacing, handrails, drop, access ramp w/ retaining wall	1	LS
5	Advance line constructed take off ramp, steel substructure rough sawn cedar finish, 6' tall	4	LS
6	Intermediate line constructed take off ramp, steel substructure rough sawn cedar finish, 4' tall	4	LS
7	Beginner line constructed take off ramp, steel substructure rough sawn cedar finish, 3' tall	4	LS
		Sub Total	\$
Add Alternates			
1	Trex Decking upgrade to boardwalk	1845 SQ FT	\$
2	Trail Carsonite Signage Posts	24 LS	\$
3	Trail Entrance Arch	1 LS	\$
4	Trail Map Kiosk	1 LS	\$
5	Pump Track & Skills Park Kiosk	1 LS	\$
6	Pump Track Skate park inspired features, bidder to provide description	2 LS	\$
7	Pump Track Curved Wall Ride, 30' Long	1 LS	\$
8	Advance skills line wall ride, 20' long	1 LS	\$
9	Push bike track (strider bike)	1 LS	\$
10	Live Edge Cedar Benches w/ Steel Frame	6 LS	\$
		Sub Total	\$
		Total	\$

Addenda Received: _____

Required MWBE Forms Included: _____

Bid reviewed, prepared and submitted by:

Company Name: _____

Date: _____

Address: _____

Phone Number: _____

General Contractor's License
Number: _____

Signed: _____ Print Name: _____

- A. **SUBCONTRACTORS:** Prior to the execution of a contract, the successful bidder hereby agrees to provide City of Greenville with a list of all other subcontractors (name, address, telephone number, contact person, etc.):
- B. **EXTENDED PROPOSAL:** Bidder agrees that this bid shall be valid and may not be withdrawn for a period of sixty (60) calendar days after the closing time for receiving bids.
- C. **CONTRACT TIME:** The Undersigned further agrees to commence said work upon receipt of the Notice to Proceed issued by the City and to complete the same within **Three hundred and sixty-five (365)** Calendar days after date of the Notice to Proceed.
- D. **LIQUIDATED DAMAGES FOR SUBSTANTIAL COMPLETION:** The Undersigned agrees that, from the compensation otherwise to be paid, the Owner may retain the sum of One Thousand and No Dollars (\$1,000.00) for each calendar day that the entire Work remains incomplete after thirty (30) calendar days following the date of Substantial Completion issued by the Designer or Owner, which sum is agreed upon as the proper measure of liquidated damages which the Owner will sustain per diem by the failure of the Undersigned to complete the work at the time stipulated in the Contract. This sum is not to be construed in any sense a penalty.
- E. **FINAL COMPLETION / FINAL ACCEPTANCE:** The Undersigned agrees to complete all the Work within thirty (30) calendar days after the date of Substantial Completion.

ALTERNATES

Should any of the alternates as described in the contract documents be accepted, the amount written below shall be the amount to be "added to" the base bid.

REQUIRED FORMS

The following forms have been completed by the CONTRACTOR and are attached hereto. CONTRACTOR to sign.

MBE / WBE Form(s):

Refer to the Instructions section found on page 3 of the MBE / WBE Forms in the Project Manual.

Bid Bond for City of Greenville:

Refer to the Bid Bond forms found in the Project Manual. *Use these forms, only if required.*

Respectfully submitted this _____ day of _____, 2022.

Signature: _____

Title: _____

Firm: _____

Address: _____

License No. _____ Expiration Date: _____

BID BOND for the City of Greenville

Contract name and number or other description of the Contract:

Name of Bidder:

Name, address, and telephone number of Surety's N. C. Resident Agent:

Telephone number of Surety's home office:

Surety is a corporation organized and existing pursuant to the laws of the State of:

Amount of this bond: check (a) or (b):

____(a) *(write or type the amount in words and figures)* All numbers in this section are in U. S. dollars.

(\$ _____)

____(b) five percent of the amount of the proposal

Bond number:

Date of execution of this bond:

Obligee: CITY OF GREENVILLE, a North Carolina municipal corporation.

* * * * *

KNOW ALL PERSONS BY THESE PRESENTS, that the Surety executing this bond, which Surety is duly licensed to act as surety in North Carolina, is held and firmly bound unto the City of Greenville, Obligee, in the penal sum of the amount stated above, for the payment of which sum, well and truly to be made, the Surety binds itself and its successors and assigns, jointly and severally, by these presents. Whereas the Bidder is herewith submitting a proposal for the Contract referred to above, and the Bidder desires to file this Bid Bond in lieu of making the cash deposit pursuant to G.S. 143-129; NOW THEREFORE, THE CONDITION OF THE ABOVE OBLIGATION is such, that if the Bidder shall be awarded the contract for which the bond is submitted, and shall, within ten days after the award is made, execute and deliver to the Obligee the contract and give satisfactory surety as required by G.S. 143-129, then this obligation shall be null and void, otherwise to remain in full force and virtue; and if the Bidder fails or refuses to so execute and deliver said contract or give said satisfactory surety, the Surety shall upon demand forthwith pay to the Obligee the full penal sum of this bond. The Surety waives all extensions of time, and notice of extensions of time, for the opening of proposals and for the modification, award, execution, and delivery of the contract. IN WITNESS WHEREOF, the Surety has executed this instrument under its seal as of the date of execution indicated above, pursuant to authority of its governing body.

(name of Surety)

(signature of Surety's attorney in fact)
(Affix Surety's corporate seal)

(Instructions to Surety: If you use a raised corporate seal, press hard enough to make it legible.)

ACKNOWLEDGMENT OF SURETY'S EXECUTION OF BID BOND

State of _____ County of _____

I, _____, a notary public in and for said county and state, certify that _____ personally appeared before me this day and acknowledged that he or she is Attorney in Fact for

_____, the Surety named in the foregoing Bid Bond, in which bond the Obligee is the City of Greenville, and that he or she executed said bond, under the seal of the Surety, on behalf of the Surety.

This the _____ day of _____, 20_____.

My commission expires: _____

Notary Public

PERFORMANCE BOND AND PAYMENT BOND

Date of Contract: _____

Contract Name and Number: _____

Name of Principal (Name of Contractor): _____

The Principal is organized and existing under the laws of the following State:

Name of Surety: _____

Name, address, and telephone number of Surety's N. C. Resident Agent:

Amount of Performance Bond (in words and figures):

(\$) _____

_____ **dollars**

Bond number: _____

Date of Execution of these Bonds: _____

Contracting Body: **CITY OF GREENVILLE, a North Carolina municipal corporation.**
Amount of Payment Bond: **same dollar amount as the dollar amount of the Performance Bond.**

KNOW ALL PERSONS BY THESE PRESENTS, That we, the PRINCIPAL AND SURETY above named, are held and firmly bound unto the above named Contracting Body, hereinafter called the Contracting Body, in the penal sum of the amount stated above for the payment of which sum well and truly to be made, we bind ourselves, our heirs, executors, administrators, and successors, jointly and severally, by these presents.

THE CONDITION OF THIS OBLIGATION IS SUCH, that whereas the Principal entered into a certain contract with the Contracting Body, numbered as shown above and hereto attached:

NOW THEREFORE, if the Principal shall well and truly perform and fulfill all the undertakings, covenants, terms, conditions, and agreements of said contract during the original term of said contract and any extensions thereof that may be granted by the Contracting Body, with or without notice to the Surety, and during the life of any guaranty required under the contract, and shall also well and truly perform and fulfill all the undertakings, covenants, terms, conditions, and agreements of any and all duly authorized modifications of said contract that may hereafter be made, notice of which modifications to the Surety being hereby waived, then this obligation to be void; otherwise to remain in full force and virtue. As used hereinabove, "modifications" shall include, without limitation, changes (including, without limitation, changes granting extensions of time) and additions to or with respect to the work, scope of work, and specifications. The undertakings, covenants, terms, conditions, and agreements of said contract shall include, without limitation, the Principal's obligations, if any, with respect to damages for delay, to indemnify, and to provide warranties.

KNOW ALL PERSONS BY THESE PRESENTS, That we, the PRINCIPAL AND SURETY above named, are held and firmly bound unto the above named Contracting Body, hereinafter called the Contracting Body, in the penal sum of the amount stated above for the payment of which sum well and truly to be made, we bind ourselves, our heirs, executors, administrators, and successors, jointly and severally, by these presents.

THE CONDITION OF THIS OBLIGATION IS SUCH, that whereas the Principal entered into a certain contract with the Contracting Body, numbered as shown above and hereto attached:

NOW THEREFORE, if the Principal shall promptly make payment to all persons supplying labor and material in the prosecution of the work provided for in said contract, and any and all duly authorized modifications of said contract that may hereafter be made, notice of which modifications to the Surety being hereby waived, then this obligation to be void; otherwise to remain in full force and virtue. As used hereinabove, "modifications" shall include, without limitation, changes (including, without limitation, changes granting extensions of time) and additions to or with respect to the work, scope of work, and specifications.

The Performance Bond and the Payment Bond are being combined here only for purposes of convenience in signing and acknowledging, and the obligations of the Principal and of the Surety are the same as if the bonds were on separate documents. Each bond is in the dollar amount stated above, and the amounts of these bonds are not combined. The Surety agrees that both of these bonds are fully binding on it whether or not the Principal executes these bonds. These bonds are given pursuant to Article 3 of Chapter 44A of the N. C. General Statutes.

IN WITNESS WHEREOF, the above-bounden parties have executed this instrument (for both the Performance Bond and the Payment Bond) under their several seals on the date of execution indicated above, the name and corporate seal of each corporate party being hereto affixed and these presents duly signed by its undersigned representative, pursuant to authority of its governing body.

(name of Principal)

[Execution by Principal when the Principal is a corporation]

By: _____
Title of officer: _____

(Affix Principal's corporate seal.)

[Execution by Principal when the Principal is a limited liability company]

By: _____
Manager of Principal

[Surety's execution]

(name of Surety)

(signature of attorney in fact)
(Affix Surety's corporate seal.)

*(Instructions to Surety and Principal: **If you use a raised corporate seal, press hard enough to make it legible.**)*

ACKNOWLEDGMENT OF CONTRACTOR'S EXECUTION OF CONTRACT AND PERFORMANCE BOND
AND PAYMENT BOND

[Acknowledgment when the Contractor (the Principal) is a corporation]

State of _____ County of _____

I, a notary public in and for the aforesaid county and state, certify that

_____ personally appeared before me this day and stated that he or she is **(strike through the inapplicable:)** chairperson/ president/ chief executive officer/ vice-president/ assistant vice-president/ treasurer/ chief financial officer of _____, a corporation, and that by authority duly given and as the act of the corporation, he or she signed the foregoing contract with the City of Greenville and Performance Bond and Payment Bond with respect to the contract and the corporate seal was affixed to said instrument(s). This the _____ day of _____, 20____.

My commission expires: _____
Notary Public

[Acknowledgment when the Contractor (the Principal) is a limited liability company]

State of _____ County of _____

I, _____, a notary public for said county and state, certify that _____ (1) appeared before me this day, (2) stated that he or she is a manager of _____, a limited liability company, (3) acknowledged that the foregoing contract with the City of Greenville and the Performance Bond and Payment Bond with respect to the contract carry on the company's business in the usual way, and (4) acknowledged the due execution of the contract and the Performance Bond and Payment Bond on behalf of the company.

This the _____ day of _____, 20_____.

My commission expires: _____
Notary Public

ACKNOWLEDGMENT OF SURETY'S EXECUTION OF PERFORMANCE BOND AND PAYMENT BOND

State of _____

County of _____

I, a notary public in and for the aforesaid county and state, certify that
_____ personally appeared before me this day
and stated that he or she is Attorney in Fact for

_____,
the Surety named in the foregoing Performance Bond and Payment Bond, in both of which bonds the
contracting body is the City of Greenville, and that he or she executed said bonds, under the seal of the
Surety, on behalf of the Surety.

This the _____ day of _____, 20_____

My commission expires: _____

Notary Public

**City of Greenville/Greenville Utilities Commission Minority and
Women Business Enterprise (MWBE) Program**

**City of Greenville
Construction Guidelines and Affidavits
\$100,000 and above**

These instructions shall be included with each bid solicitation.

City of Greenville/Greenville Utilities Commission Minority and Women Business Enterprise Program

\$100,000 and Construction Guidelines for MWBE Participants

Policy Statement

It is the policy of the City of Greenville and Greenville Utilities Commission to provide minorities and women equal opportunity for participating in all aspects of the City’s and Utilities’ contracting and procurement programs, including but not limited to, construction projects, supplies and materials purchases, and professional and personal service contracts.

Goals and Good Faith Efforts

Bidders responding to this solicitation shall comply with the MWBE program by making Good Faith Efforts to achieve the following aspiration goals for participation.

	CITY	
	MBE	WBE
Construction This goal includes Construction Manager at Risk.	10%	6%

Bidders shall submit MWBE information with their bids on the forms provided. This information will be subject to verification by the City prior to contract award. **As of July 1, 2009, contractors, subcontractors, suppliers, service providers, or MWBE members of joint ventures intended to satisfy City MWBE goals shall be certified by the NC Office of Historically Underutilized Businesses (NC HUB) only.** Firms qualifying as “WBE” for City’s goals must be designated as a “women-owned business” by the HUB Office. Firms qualifying as “MBE” for the City’s goals must be certified in one of the other categories (i.e.: Black, Hispanic, Asian American, American Indian, Disabled, or Socially and Economically Disadvantaged). Those firms who are certified as both a “WBE” and “MBE” may only satisfy the “MBE” requirement. **Each goal must be met separately. Exceeding one goal does not satisfy requirements for the other.** A complete database of NC HUB certified firms may be found at <http://www.doa.nc.gov/hub/>. An internal database of firms who have expressed interest to do business with the City and GUC is available at www.greenvillenc.gov. However, the HUB status of these firms must be verified by the HUB database. The City shall accept NCDOT certified firms on federally funded projects only. **Please note: A contractor may utilize any firm desired. However, for participation purposes, all MWBE vendors who wish to do business as a minority or female must be certified by NC HUB.**

The Bidder shall make good faith efforts to encourage participation of MWBEs prior to submission of bids in order to be considered as a responsive bidder. Bidders are cautioned that even though their submittal indicates they will meet the MWBE goal, they should document their good faith efforts and be prepared to submit this information, if requested.

The MWBE’s listed by the Contractor on the **Identification of Minority/Women Business Participation** which are determined by the City to be certified shall perform the work and supply the materials for which they are listed unless the Contractors receive prior authorization from the City to perform the work with other forces or to obtain materials from other sources. If a contractor is proposing to perform all elements of the work with his own forces, he must be prepared to document evidence satisfactory to the owner of similar government contracts where he has self-performed.

The Contractor shall enter into and supply copies of fully executed subcontracts with each MWBE or supply signed Letter(s) of Intent to the Project Manager after award of contract and prior to Notice to Proceed. Any amendments to subcontracts shall be submitted to the Project Manager prior to execution.

Instructions

The Bidder shall provide with the bid the following documentation:

- Identification of Minority/Women Business Participation (if participation is zero, please mark zero—Blank forms will be considered nonresponsive)
- Affidavit A (if subcontracting)
- OR
- Identification of Minority/Women Business Participation (if participation is zero, please mark zero—Blank forms will be considered nonresponsive)
- Affidavit B (if self-performing; will need to provide documentation of similar projects in scope, scale, and cost)

Within 72 hours or 3 business days after notification of being the apparent low bidder who is subcontracting anything must provide the following information:

- Affidavit C (if aspirational goals are met or are exceeded)
- OR
- Affidavit D (if aspirational goals are not met)
- After award of contract and prior to issuance of notice to proceed: Letter(s) of Intent or Executed Contracts

****With each pay request, the prime contractors will submit the Proof of Payment Certification, listing payments made to MWBE subcontractors.**

*****If a change is needed in MWBE Participation, submit a Request to Change MWBE Participation Form. Good Faith Efforts to substitute with another MWBE contractor must be demonstrated.**

Minimum Compliance Requirements:

All written statements, affidavits, or intentions made by the Bidder shall become a part of the agreement between the Contractor and the City for performance of contracts. Failure to comply with any of these statements, affidavits or intentions or with the minority business guidelines shall constitute a breach of the contract. A finding by the City that any information submitted (either prior to award of the contract or during the performance of the contract) is inaccurate, false, or incomplete, shall also constitute a breach of the contract. Any such breach may result in termination of the contract in accordance with the termination provisions contained in the contract. It shall be solely at the option of the City whether to terminate the contract for breach or not. In determining whether a contractor has made Good Faith Efforts, the CITY will evaluate all efforts made by the Contractor and will determine compliance in regard to quantity, intensity, and results of these efforts.

Identification of Minority/Women Business Participation

I, _____
(Name of Bidder)

do hereby certify that on this project, we will use the following minority/women business enterprises as construction subcontractors, vendors, suppliers or providers of professional services.

Firm Name, Address and Phone #	Work type	*MWBE Category

*MWBE categories: Black, African American (**B**), Hispanic, Latino (**L**), Asian American (**A**) American Indian (**I**), Female (**F**) Socially and Economically Disadvantaged (**S**) Disabled (**D**)

If you will not be utilizing MWBE contractors, please certify by entering zero "0"

The total value of MBE business contracting will be (\$) _____

The total value of WBE business contracting will be (\$) _____

City of Greenville **AFFIDAVIT A – Listing of Good Faith Efforts**

County of _____

(Name of Bidder)

Affidavit of _____

I have made a good faith effort to comply under the following areas checked:

Bidders must earn at least 50 points from the good faith efforts listed for their bid to be considered responsive. (1 NC Administrative Code 30 I.0101)

- 1 – (10 pts)** Contacted minority businesses that reasonably could have been expected to submit a quote and that were known to the contractor, or available on State or local government maintained lists, at least 10 days before the bid date and notified them of the nature and scope of the work to be performed.
- 2 --(10 pts)** Made the construction plans, specifications and requirements available for review by prospective minority businesses or providing these documents to them at least 10 days before the bids are due.
- 3 – (15 pts)** Broken down or combined elements of work into economically feasible units to facilitate minority participation.
- 4 – (10 pts)** Worked with minority trade, community, or contractor organizations identified by the Office of Historically Underutilized Businesses and included in the bid documents that provide assistance in recruitment of minority businesses.
- 5 – (10 pts)** Attended prebid meetings scheduled by the public owner.
- 6 – (20 pts)** Provided assistance in getting required bonding or insurance or provided alternatives to bonding or insurance for subcontractors.
- 7 – (15 pts)** Negotiated in good faith with interested minority businesses and did not reject them as unqualified without sound reasons based on their capabilities. Any rejection of a minority business based on lack of qualification should have the reasons documented in writing.
- 8 – (25 pts)** Provided assistance to an otherwise qualified minority business in need of equipment, loan capital, lines of credit, or joint pay agreements to secure loans, supplies, or letters of credit, including waiving credit that is ordinarily required. Assisted minority businesses in obtaining the same unit pricing with the bidder's suppliers in order to help minority businesses in establishing credit.
- 9 – (20 pts)** Negotiated joint venture and partnership arrangements with minority businesses in order to increase opportunities for minority business participation on a public construction or repair project when possible.
- 10 - (20 pts)** Provided quick pay agreements and policies to enable minority contractors and suppliers to meet cash-flow demands.

The undersigned, if apparent low bidder, will enter into a formal agreement with the firms listed in the Identification of Minority/Women Business Participation schedule conditional upon scope of contract to be executed with the Owner. Substitution of contractors must be in accordance with GS143-128.2(d) Failure to abide by this statutory provision will constitute a breach of the contract.

The undersigned hereby certifies that he or she has read the terms of the minority/women business commitment and is authorized to bind the bidder to the commitment herein set forth.

Date: _____ Name of Authorized Officer: _____

Signature: _____

Title: _____

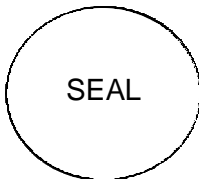

State of _____, County of _____

Subscribed and sworn to before me this ____ day of _____ 20____

Notary Public _____

My commission expires _____

Attach to Bid Attach to Bid Attach to Bid Attach to Bid Attach to Bid Attach to Bid Attach to Bid Attach to Bid

City of Greenville --AFFIDAVIT B-- Intent to Perform Contract with own Workforce.

County of _____

Affidavit of _____
(Name of Bidder)

I hereby certify that it is our intent to perform 100% of the work required for
the _____ contract.
(Name of Project)

In making this certification, the Bidder states that the Bidder does not customarily subcontract elements of this type project, and normally performs and has the capability to perform and will perform all elements of the work on this project with his/her own current work forces; and

The Bidder agrees to provide any additional information or documentation requested by the owner in support of the above statement.

The undersigned hereby certifies that he or she has read this certification and is authorized to bind the Bidder to the commitments herein contained.

Date _____ Name of Authorized Officer: _____

Signature: _____

Title: _____

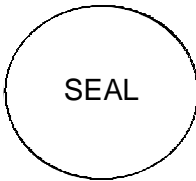

State of _____, County of _____

Subscribed and sworn to before me this _____ day of _____ 20____

Notary Public _____

My commission expires _____

City of Greenville - AFFIDAVIT C –

Portion of the Work to be Performed by MWBE Firms

County of _____

(Note this form is to be submitted only by the apparent lowest responsible, responsive bidder.)

If the portion of the work to be executed by MWBE businesses as defined in GS143-128.2(g) and the COG/CITY MWBE Plan sec. III is equal to or greater than 16% of the bidders total contract price, then the bidder must complete this affidavit. This affidavit shall be provided by the apparent lowest responsible, responsive bidder within **72 hours** after notification of being low bidder.

Affidavit of _____ I do hereby certify that on the
(Name of Bidder)

(Project Name)

Project ID# _____ Amount of Bid \$ _____

I will expend a minimum of _____ % of the total dollar amount of the contract with minority business enterprises and a minimum of _____ % of the total dollar amount of the contract with women business enterprises. Minority/women businesses will be employed as construction subcontractors, vendors, suppliers or providers of professional services. Such work will be subcontracted to the following firms listed below.

Attach additional sheets if required

Name and Phone Number	*MWBE Category	Work description	Dollar Value

*Minority categories: Black, African American (**B**), Hispanic or Latino (**L**), Asian American (**A**)
American Indian (**I**), Female (**F**) Socially and Economically Disadvantaged (**S**)
Disabled (**D**)

Pursuant to GS143-128.2(d), the undersigned will enter into a formal agreement with MWBE Firms for work listed in this schedule conditional upon execution of a contract with the Owner. Failure to fulfill this commitment may constitute a breach of the contract.

The undersigned hereby certifies that he or she has read the terms of this commitment and is authorized to bind the bidder to the commitment herein set forth.

Date: _____ Name of Authorized Officer: _____

Signature: _____

Title: _____



State of _____, County of _____

Subscribed and sworn to before me this _____ day of _____ 20_____

Notary Public _____

My commission expires _____

City of Greenville **AFFIDAVIT D – Good Faith Efforts**

County of _____

(Note this form is to be submitted only by the apparent lowest responsible, responsive bidder.)

If the goal of 16% participation by minority/women business **is not** achieved, the Bidder shall provide the following documentation to the Owner of his good faith efforts:

Affidavit of _____ I do hereby certify
(Name of Bidder)

that on the _____
(Project Name)

Project ID# _____ Amount of Bid \$ _____

I will expend a minimum of _____ % of the total dollar amount of the contract with minority business enterprises and a minimum of _____ % of the total dollar amount of the contract with women business enterprises. Minority/women businesses will be employed as construction subcontractors, vendors, suppliers or providers of professional services. Such work will be subcontracted to the following firms listed below. (Attach additional sheets if required)

Name and Phone Number	*MWBE Category	Work description	Dollar Value

*Minority categories: Black, African American (**B**), Hispanic or Latino (**L**), Asian American (**A**) American Indian (**I**), Female (**F**) Socially and Economically Disadvantaged (**S**) Disabled (**D**)

Examples of documentation required to demonstrate the Bidder's good faith efforts to meet the goals set forth in these provisions include, but are not necessarily limited to, the following:

- A. Copies of solicitations for quotes to at least three (3) minority business firms from the source list provided by the State for each subcontract to be let under this contract (if 3 or more firms are shown on the source list). Each solicitation shall contain a specific description of the work to be subcontracted, location where bid documents can be reviewed, representative of the Prime Bidder to contact, and location, date and time when quotes must be received.
- B. Copies of quotes or responses received from each firm responding to the solicitation.
- C. A telephone log of follow-up calls to each firm sent a solicitation.
- D. For subcontracts where a minority business firm is not considered the lowest responsible sub-bidder, copies of quotes received from all firms submitting quotes for that particular subcontract.
- E. Documentation of any contacts or correspondence to minority business, community, or contractor organizations in an attempt to meet the goal.
- F. Copy of pre-bid roster.
- G. Letter documenting efforts to provide assistance in obtaining required bonding or insurance for minority business.
- H. Letter detailing reasons for rejection of minority business due to lack of qualification.
- I. Letter documenting proposed assistance offered to minority business in need of equipment, loan capital, lines of credit, or joint pay agreements to secure loans, supplies, or letter of credit, including waiving credit that is ordinarily required.

Failure to provide the documentation as listed in these provisions may result in rejection of the bid and award to the next lowest responsible and responsive bidder.

Do not submit with the bid Do not submit with the bid Do not submit with the bid Do not submit with the bid

Pursuant to GS143-128.2(d), the undersigned will enter into a formal agreement with MWBE Firms for work listed in this schedule conditional upon execution of a contract with the Owner. Failure to fulfill this commitment may constitute a breach of the contract.

The undersigned hereby certifies that he or she has read the terms of this commitment and is authorized to bind the bidder to the commitment herein set forth.

Date: _____ Name of Authorized Officer: _____

Signature: _____

Title: _____



State of _____ County of _____

Subscribed and sworn to before me this _____ day of _____ 20

Notary Public _____

My commission expires _____

LETTER OF INTENT

MWBE Subcontractor Performance

Please submit this form or executed subcontracts with MWBE firms after award of contract and prior to issuance of notice to proceed.

PROJECT: _____
(Project Name)

TO: _____
(Name of Prime Bidder/Architect)

The undersigned intends to perform work in connection with the above project as a:

____Minority Business Enterprise ____Women Business Enterprise

The MWBE status of the undersigned is certified the NC Office of Historically Underutilized Businesses (required). ____Yes __No

The undersigned is prepared to perform the following described work or provide materials or services in connection with the above project at the following dollar amount:

Work/Materials/Service Provided	Dollar Amount of Contract	Projected Start Date	Projected End Date

(Date)

(Address)

(Name & Phone No. of MWBE Firm)

(Name & Title of Authorized Representative of MWBE)

(Signature of Authorized Representative of MWBE)

REQUEST TO CHANGE MWBE PARTICIPATION

(Submit changes only if notified as apparent lowest bidder, continuing through project completion)

Project: _____

Bidder or Prime Contractor: _____

Name & Title of Authorized Representative: _____

Address: _____ **Phone #:** _____

Email Address: _____

Total Contract Amount (including approved change orders or amendments): \$ _____

Name of subcontractor: _____

Good or service provided: _____

Proposed Action:

Replace subcontractor

Perform work with own forces

For the above actions, you must provide one of the following reasons (Please check applicable reason):

The listed MBE/WBE, after having had a reasonable opportunity to do so, fails or refuses to execute a written contract.

The listed MBE/WBE is bankrupt or insolvent.

The listed MBE/WBE fails or refuses to perform his/her subcontract or furnish the listed materials.

The work performed by the listed subcontractor is unsatisfactory according to industry standards and is not in accordance with the plans and specifications; or the subcontractor is substantially delaying or disrupting the progress of the work.

If replacing subcontractor:

Name of replacement subcontractor: _____

The MWBE status of the contractor is certified by the NC Office of Historically Underutilized Businesses (required). ___Yes___ No

Dollar amount of original contract \$ _____

Dollar amount of amended contract \$ _____

Other Proposed Action:

___ Increase total dollar amount of work
___ Decrease total dollar amount of

___ Add additional subcontractor
___ Other

Please describe reason for requested action: _____

If adding additional subcontractor:*

The MWBE status of the contractor is certified by the NC Office of Historically Underutilized Businesses (required). Yes No

**Please attach Letter of Intent or executed contract document*

Dollar amount of original contract \$ _____

Dollar amount of amended contract \$ _____

Interoffice Use Only:

Approval Y N

Date _____

Signature _____

Pay Application No. _____ Purchase Order No. _____

Proof of Payment Certification

MWBE Contractors, Suppliers, Service Providers

Project Name: _____

Prime Contractor: _____

Current Contract Amount (including change orders): \$ _____

Requested Payment Amount for this Period: \$ _____

Is this the final payment? _____ Yes _____ No

Firm Name	MWBE Category*	Total Amount Paid from this Pay Request	Total Contract Amount (including changes)	Total Amount Remaining

*Minority categories: Black, African American (B), Hispanic or Latino (L), Asian American (A) American Indian (I), Female (F)
 Socially and Economically Disadvantaged (S) Disabled (D)

Date: _____

Certified By: _____

Name

Title

Signature

PART II

CONSTRUCTION SPECIFICATIONS

Wildwood Park Bike Trails General Notes

- It is required that Qualified Trail Contractor must have a minimum three years experience of work on public projects that includes: singletrack trails, gravity jump trails, pump tracks, dirt jumps and other mountain bike trail elements.
- It is required that Qualified Trail Contractor be able to submit (3) three project references. It is acceptable to submit a single page reference sheet that includes project descriptions, scope of work, contract amount, start and completion dates, and reference contact information. The (3) three project references may consist of (1) Trail Project Reference, (1) Pumptrack Project Reference, and (1) Skills Park Project Reference.
- It is required that Qualified Trail Contractor be a licensed General Contractor in the state of North Carolina due to the scope of the project.
- It is the responsibility of the Qualified Trail Contractor to secure the required building permits.
- Contractor responsible for field layout of all new improvements. Digital files of the proposed design will be provided upon request.
- All trail construction shall comply with the specifications, drawings, requirements, and design intent prescribed in the construction and contract Documents. Acceptable modifications shall be presented by the Trail Contractor to the Owner's Representative for approval in writing. Field fit modifications are encouraged when necessary to ensure proper flow and function of trail features.
- Contractor to avoid any site disturbance beyond the necessary limits of construction to the extent possible. Any areas disturbed during construction activities shall be revegetated and restored to professionally finished conditions. Minimize disturbance to existing vegetation.
- Contractor responsible to coordinate delivery, assembly and installation of all materials and furnishings per manufacturer's instructions.
- Contractor shall designate an experienced Test Rider with expert knowledge of the intended experience to oversee construction of this project. This Test Rider shall thoroughly test ride all trails and trail features to ensure the specified riding experience, design, flow, rhythm, character, difficulty, and specifications are met.
- Prior to construction, contractor shall contact all utility companies potentially involved in or having facilities on or near the site. Contractor shall contact North Carolina 811 (www.nc811.org) underground service alert program a minimum of two working days in advance of any excavation or grading work. Bike Park Design shall not be held liable for the existence or location of any underground utilities or other buried objects.
- Completed bike park shall reflect professional workmanship in appearance, quality, and attention to detail. Trails and features shall be well integrated into site, aesthetically pleasing in appearance, and well-shaped, crafted, and finished according to commonly accepted best practices for high quality and sustainable mountain biking trails. Work must be completed to the satisfaction of the Owner's Representative.
- The Trail Contractor shall be responsible for fine grading and positive drainage away from all trails and trail features. No ponding of surface water shall be on or adjacent to the trail surface. During construction, additional drainage methods may be necessary by the Contractor to promote positive site drainage. All drainage methods, devices and locations shall be employed in accordance with professional trail building standards and approval by Owner's Representative.
- Fill needed for construction of trails and features may be generated during trail excavation, borrowed from surrounding landscape where appropriate, borrowed from



onsite stockpiles, or imported when necessary. Material shall be uncontaminated and free of organic material, trash, and other objects. Fill material shall be screened to 4", placed, graded, and compacted by Contractor in a manner that will support the intended use.

- The intent of the Cap material is to cover the existing Fill soils with a minimum 4" layer of professionally-finished surface that facilitates drainage, compacts well, and accommodates riders in reasonably variable wet & dry conditions. 3/8" minus screened mix consisting of 60% sand, 20% clay, 15% silt and 5% gravel; or similar alternative to be approved by Owner's Representative. Refer to soils specifications for additional information.
- For all Fill & Cap materials specified, it shall be understood and agreed that quantities listed are estimated only and may be increased or decreased on a unit cost basis as needed to meet feature specifications.
- All trails and features shall be compacted to 90% density in a manner that will support the intended use.
- Imported boulder and rock materials shall be consistent with or match onsite materials. To be approved by Owner's Representative.

Wildwood Park Bike Trail Singletrack Construction

Sec 1 - General Notes

1.1 - Summary

- The Wildwood park project consists of building approximately 31,700 linear feet of single track mountain bike trail and associated Skills Park and Pump Track
- All trail construction shall be constructed to sustainable standards as described in *IMBA's Trail Solutions: IMBA's Guide To Building Sweet Singletrack (June, 2004)*.
- All single track trail shall resemble USFS Trail Class 3.

1.2 - Quality Assurance

- All communications shall be made by the general contractor to the project manager. Sub-contractors shall bring issues to the general contractor's attention who will then bring them to the project manager's attention. The project manager for the owner will be:
- Trail construction shall be conducted by a professional firm that can demonstrate significant and successful experience in the field of mountain bike-optimized natural surface trail development.

Sec 2 - Product

2.1 - Materials

- Mineral soils free of organics shall be used for all trail tread.
- All wood shall be treated marine grade or rot resistant native species (Eastern Red Cedar, Black Locust, Bald Cypress).
- All stone steppers used in trail tread shall be a minimum of 18" and 4" in thickness.

Sec 3 - Execution

3.1- Tree Protection

- All trees 6" DBH (diameter breast height) shall not be scared, skinned, or damaged by trail equipment. Where damage is likely, the tree bark shall be protected.
- Trees shall be pruned at the bark collar and not flush cut.
- Do not excavate in tree protection zone unless otherwise indicated.

3.2- Trail Corridor

- Clearing shall be within 10' of the construction flag line.

- Trees over 6" DBH shall not be removed without prior approval.
- Trail corridor shall be 48" wide unless noted for unique sections.
- Trail corridor shall be cleared 10' above the trail.
- All vegetation cut from the trail corridor shall be moved at a minimum of 30' from any trail corridor.
- Any vegetation removed shall be cut to lay flat with cut ends pointing away from the trail.

3.3- Site Improvements

- The trail consists of approximately 31,700 linear feet of trail with 3000 sq ft of permitted wetland construction.
- Trail tread is between 24" and 36" wide.
- All tread shall be out sloped at 2% to 6%
- Grades shall not exceed 10% for an extended period, short stretches (under 100') are allowed to be 15% grade.
- All bench cut trail shall be constructed as "Full Bench Cut" as described in the IMBA book *IMBA's Trail Solutions: IMBA's Guide To Building Sweet Singletrack (June, 2004)*.
- The excess soil shall not appear to be part of the trail tread and shall not form a berm on the outer edge of the tread that will restrict the natural flow of water off the trail. Excess soil shall be covered with leaves and other organic debris to resemble the surrounding forest floor. The back slope shall transition smoothly to the hillside above.
- Tread obstacles cannot exceed height listed in individual trail specifications. The trail tread shall have a compacted mineral soil surface. Compaction shall be completed using a mechanized tamper such as a vibrating plate compactor to 90% relative compaction. The trail bed shall be shaped to leave an even, compacted, uniform surface free of indentations or protruding severed roots and stumps. The grading of trail tread, back slope, and drainage features shall be finished to a stable surface.
- The contractor shall not complete more than 500 feet of new trail construction before "finishing" the trail tread and backslope. Disturbed soil outside of the trail tread and backslope shall be covered with dead vegetation, rocks and/or other approved natural materials to aid with sedimentation control and aesthetics. There shall be 50% coverage at a minimum.
- Borrow pit development shall take place within 5' of the trail centerline with all borrow pits and access routes stabilized and naturalized

3.4- Erosion Control

- No more than 500 LnFt of trail shall be left unfinished at any period.
- In areas where the trail crosses drainage swales with potential for water flow, straw wattles a minimum of eight inches in diameter shall be installed downhill of the trail tread and any disturbed and un-compacted soil.

Sec 4 - Equipment

- All machines must be in professional working condition and free of any fluid leaks.
- If a machine develops a leak it must be removed from service immediately and can not be utilized until repaired.
- Primary trail construction equipment shall not be wider than the finished trail tread.
- Support equipment may be utilized to move imported materials to specified staging locations.
- Support equipment can not travel across delineated wetlands.
- Any machine access paths must be obliterated prior to contract completion.

- Due to the nature of the landscape, all machines used in trail construction must be under 4.8 psi ground pressure.

Sec 5 - Wetlands Construction

- Wetland construction specifications supersede any other specifications.
- Only primary construction equipment is allowed in delineated wetlands.
- Soil disturbance shall be limited to trail tread width.
- No trail tread shall be left unfinished at the end of each work day.

Wildwood Park Pump Track Construction

Sec 1 - General Notes

1.1 - Summary

- The Wildwood Park pump track and skills area construction consists of a feature based bicycle skills park with jump features and a pavement finished pump track.
- All trail construction shall be constructed to professional standards with consideration for longevity of the features.

1.2 - Scope of Work

- All work as indicated on the plans and specifications.
- All off-haul of spoils and debris and lawful disposal.
- Pump Track grading must be performed by a pre-qualified Contractor.
- All work necessary for a complete and functional Pump Track.
- All site furnishings, signage, and installations.
- All temporary facilities, erosion control, Limits of Disturbance/Silt Fencing, and equipment to accommodate work and workers.
- Monitoring and maintenance of erosion control measures.
- All dewatering, tarping, tilling, etc. as necessary to accommodate project schedule at no additional costs.
- Project Closeout documents.

Sec 2 - Pump Track Specifications

2.1 - Site Work

- Sitework, erosion control measures, and drainage must be completed before construction of pump track fill grades commence.
- All reasonable attempts shall be made to leave trees larger than 6" DBH for the purposes of shade.

2.2 - General

- Clearing and grubbing operations and Mass Earthwork and Grading to be completed per these plans and specifications and the project general conditions.
- Written dimensions are to take precedence over scaled dimensions. Notify the Owner's Representative of any discrepancies found in the field before moving forward. Failure to gain clarification from Pump Track Designer before moving forward will render the contractor responsible for all costs associated with correcting installed work to the satisfaction of the Pump Track Designer.

2.3 - Required Inspection Points

- During the course of construction, approval of Pump Track Designer shall be required:

Approval Required On:	Prior to:
1. Clearing and grubbing layout/staking	Clearing and grubbing
2. Site mass grading layout/staking	Mass grading of site
3. Rough grading	Layout of Pump Tracks and Skills Trail
4. Layout/staking of Pump Tracks/Skills Trail	Layout of riding features (berms, rollers, built features, etc.)
5. Layout/staking of riding features	Rough Grading of riding features
6. Rough Grading of riding features	Finish grading of riding features
7. Finish Grading of riding features	Final acceptance

- In the event the Contractor continues operations without receiving the above approvals, the inspector may, at his/her discretion, require the Contractor to return all construction status to the previous approval point. There shall be no additional payment for any removal or reconstruction required under this section.

2.4 - Submittals

- Description: The purpose of this section is to define the submittals required for this project. Should one of these requirements be found elsewhere in the specifications or on the plans and not be listed herein below, it shall still be the Contractor's responsibility to provide said submittals.
- The Contractor's superintendent shall retain a copy of approved submittals at the work site at all times for the Pump Track designer's use and review. The submittals shall be kept in a binder and cataloged for ease of reference. In addition, pursuant to the Standard Specifications, the contractor shall at all times have on the work site an approved and signed set of bid document plans and specifications, issued revisions and authorized change orders available for the PumpTrack designers use and review. Unless stated otherwise, it is intended that any specified material items shall be deemed to include the term "or approved equal".
- Upon receipt of the "Notice to Proceed", the Contractor shall coordinate with product manufacturer's specified herein to ensure that all materials will be available and to ensure that all materials will arrive at the job site within the time limit for completion of the project. Contractor shall not order any materials until submittals have been approved by the Owner's Representative as outlined in the project general conditions.

Sec 3 - Products

3.1 - Materials

- The Contractor shall be responsible for meeting the finish grades and building the riding features (rollers, berms, etc.) as shown on the plans. The Contractor shall provide the source of the import soil for review and approval by the Owner's Representative prior to delivery to the site.

3.2 - Fill Material

- **Soil Specification:** Soil mixtures generated from on-site excavations are not suitable for reuse as fill for the pump track unless approved by owner or Owner's Representative. Imported fill soil shall be free of organic material, debris, clods, rock, etc. and free of trash, chemicals, paints, and any other toxic substances. Imported fill soil for fine grading operations shall consist of a well graded and compacted mix of a 70% clay / 30% silt content.
- **Quantity:** Contractor is responsible for verifying import fill quantities for all grading and fill operations related to construction of the park.
- **Compacted Fill:** On-site fill, backfill, and scarified subgrades shall be moisture conditioned to within 3% of the optimum moisture content. Properly moisture conditioned and cured on-site materials shall be placed in loose horizontal lifts of 8 inches thick or less, and uniformly compacted to at least 95% relative compaction.
- **Road Base:** Road base shall be used for all fill above the existing grade for pump track construction. Suitable road base shall be approved by Owner or Owner's Representative.

3.3 - Finish Material

- **Asphalt Surface:** Asphalt shall be a 1/4" minus mix design with a thickness of no less than 3" after compaction.
- Native soil can be used to renaturalize unpaved areas and cover compacted road base.

Sec 4 - Execution

4.1 - Description

Work under this item shall include:

- Grading to achieve rough and finish grades for all Pump Track dirt riding features and the finish grading and installation of prefabricated riding features as shown on the design plans.
- Furnish and place approved import soil as necessary to meet grades for Pump Tracks and Skills Trail dirt riding features as shown on the design plans.
- Installation of drainage features.

4.2 - General

- Exact locations, distances, dimensions, elevations, etc. shall be governed by actual field conditions and verified by the Contractor.
- Excavated material shall become the property of the Contractor, and shall be off-hauled and fully disposed of unless otherwise notified by owner or owner's representative
- The contractor shall notify the owner or owner's representative immediately after identifying a grade conflict. The Contractor shall not be eligible for additional compensation for minor design changes other than those that cause a significant change in quantities.

4.3 - Layout of Improvements

- The contractor shall notify the Owner or Owner's Representative immediately after identifying a grade conflict. The Contractor shall not be eligible for additional compensation for minor design changes other than those that cause a significant change in quantities.
- The Contractor shall be responsible for all survey work and shall be responsible for replacing points lost or damaged during the course of construction. The Pump Track



Designer shall provide the Contractor with electronic copies of the Pump Track for the purpose of layout and surveying.

- The Contractor shall be responsible for the accuracy of all layout work. Equipment operators and workers are to be skilled in grading operations and are to be supervised by a competent superintendent who is familiar with the nature of the work, these provisions, and all permit conditions. All grading, sub-grading, and finished grading areas shall be controlled by such intermediate grade stakes and lines as may be necessary to obtain the slopes and levels required by the finished grade elevations shown on the plans.
- All benchmarks, monuments and other reference points shall be carefully protected and maintained at no increased cost and, if disturbed or destroyed, shall be replaced as directed by the Engineer at Contractor expense.
- Exact locations, distances, dimensions, elevations, etc. shall be governed by actual field conditions and verified by the Contractor.
- Staking of pump track layout shall be reviewed and approved by the Owner's Representative after mass grading is complete and prior to starting fine grading activities.
- The location of riding features (berms, rollers, prefabricated features, etc.) as depicted in the sign plans shall be considered approximate and requiring field fit (e.g. heights, lengths, widths, spacing between features) with oversight from the Pump Track Designer. Staking shall be reviewed and approved by the Pump Track Designer prior to starting construction and fine grading activities. The Contractor shall not be eligible for additional compensation for field fit design changes.

4.4 - Construction Methods

- Prior to grading, the site shall be cleared of all obstructions and deleterious materials. Debris and materials arising from clearing and removal operations shall be properly disposed of off-site. Surface vegetation in the location of the Pump Tracks shall be stripped and removed. Soil material containing more than 2% organic matter by weight shall be considered organic. Contractor shall plan to strip to a depth of 2 inches, actual stripping depths may be less.
- Native soil shall be cleared and grubbed of native vegetation prior to placing imported fill materials. Prior to the placement of riding features (rollers, berms, etc.) and/or fill material, the soil shall be scarified to a minimum depth of 8-12 inches, moisture conditioned, and re-compacted to a minimum 95% relative compaction to achieve optimal uniform compaction. In areas where there is existing topography and natural hill slope, features shall be excavated out of cleared and grubbed native soil and moisture-conditioned and compacted in place to the relative compaction mentioned above. Imported approved fill for riding features shall be placed and water conditioned in lifts not exceeding 8 inches in thickness (before compaction).
- No abrupt changes in slope or contour will be accepted. Contractor shall take special care to feather or taper graded areas to match grade at edge of existing landscape.
- Prior to the placement of any fill material for riding features (rollers, berms, etc.), the Contractor shall layout (stake, chalk, flag, etc.) the location of each bike park feature in order of riding direction as shown on the plans. Layout of riding features must be approved by the Pump Track Designer before feature construction. After approval of the layout, riding features shall be constructed or installed in the sequence of riding direction as shown on the plans.

- The Contractor shall be responsible for verifying actual location, shape and size of Pump Track riding features and gaining approval from the pump Track Designer prior to construction.
- The Pump Track Designer shall approve finish grades prior to removal of earth moving equipment from the project site.

Wildwood Park Bicycle Skills Park Construction

Sec 1 - General Notes

1.1 - Summary

- The Wildwood park skills park project consists of building (3) three linear jump feature lines and associated support structures.
- All reasonable attempts shall be made to leave trees larger than 6" DBH for the purposes of shade.

1.2 - Quality Assurance

- It is required that a Qualified Trail Contractor must have a minimum three years experience of work on public projects that includes singletrack trails, gravity jump trails, pump tracks, dirt jumps and other mountain bike trial elements.
- All trail construction shall comply with the specifications, drawings, requirements, and design intent prescribed in the construction and contract documents. Acceptable modifications shall be presented by the Trail Contractor to the Owner's Representative for approval in writing. Field fit modifications are encouraged when necessary to ensure proper flow and function of trail features.

Sec 2 - Trail Preparation

2.1 - Site Layout

- Contractor responsible for field layout of all new improvements. Digital files of the proposed sign and base files will be provided upon request. Provide stakes/flags at all coordinate locations and every 25 feet along centerline of all pathways for review by Owner's Representative prior to any earthwork operations
- Prior to construction, Contractor shall contact all utility companies potentially involved in or having facilities on or near the site. Contractor shall contact North Carolina 811(www.nc811.org) underground service alert program a minimum of two working days in advance of any excavation or grading work. Bike Park Designer shall not be held liable for the existence of any underground utilities or other buried objects.
- Prior to trail grading, surface vegetation in the location of trail alignments should be stripped and removed. Soil material containing organic material should be removed.

2.2 - Bike Trail Fill & Materials

- Fill needed for construction of trails and features may be generated during trail excavation, borrowed from surrounding landscape where appropriate, borrowed from onsite stockpiles, or imported when necessary. Material shall be uncontaminated and free of organic material, trash, and other objects. Fill material shall be screened to 4", placed, graded, and compacted by Contractor in a manner that will support the intended use.
- Non-expansive soil generated from on-site excavation may be suitable for use assuming material has a maximum plasticity index that meets accepted bike park trail building standards for intended use.

2.3 - Cap Material

- The intent of the Cap material is to cover the existing Fill soils with a minimum 4" layer of professionally-finished surface that facilitates drainage, compacts well, and accommodates riders in reasonably variable wet & dry conditions.
- For all Fill & Cap materials specified, it shall be understood and agreed that quantities listed are estimated only and may be increased or decreased on a unit cost basis as needed to meet feature specifications.
- Imported boulder and rock materials shall be consistent with or match onsite materials to be approved by the Owner's Representative.
- Contractor is responsible to coordinate delivery, assembly and installation of all materials and furnishings per manufacturer's instructions

2.4 - Trail Alignments and Features

- The bike skills park plan is diagrammatic and may not reflect an exact final alignment for each trail feature. All trail and feature locations are approximate and subject to on-site placement by selected Contractor.
- Trail features (rollers, berms, jumps, etc.) shown are diagrammatic and may not reflect exact alignment, location or dimension of each feature. The selected contractor shall determine the exact final location and dimension of each feature based upon final trail alignment, slope, trail flow, character and difficulty with final approval of the Owner's Representative.

2.5 - Trail Grading

- It is the intent of the trail design and grading to achieve a balance between earthwork cut and fill. Contractor shall make field adjustments while meeting all required performance specifications for bike trails, technical trail features and grading requirements herein.
- The Trail Contractor shall be responsible for fine grading and positive drainage away from all trails and trail features. No ponding of surface water shall be on or adjacent to the trail surface. During construction, additional drainage methods may be necessary by the Contractor to promote positive site drainage. All drainage methods, devices and locations shall be employed in accordance with professional trail building standards and approval by the Owner's Representative.
- Trails shall be constructed with frequent grade changes, dips, rollers, etc., to minimize water flow distances along trail surfaces and to minimize erosion.
- No abrupt changes in slope and contour will be accepted. Contractor shall take special care to taper graded areas backslopes to match grade at edge of existing landscape.
- Turns on bike skills park trails shall be banked and bermed as necessary according to specifications, drawings, intended riding experience, trail flow, speed and difficulty.

2.6 - Compaction

- All trails and features shall be compacted to 90% relative compaction in a manner that will support the intended use.

2.7 - Trail and Feature Testing

- Contractor shall designate an experienced Test Rider with expert knowledge of the intended experience to oversee construction of this project. This Test Rider shall thoroughly test ride all trails and trail features to ensure the specified riding experience, design, flow, rhythm, character, difficulty, and specifications are met.

2.8 - Skill Level

- Trails/features must be appropriate for the skill level of the typical rider for which the trail/area intended. This includes:
 - Amplitude and distance

- Speed and momentum
- Minimal braking where so intended
- Perception of challenge and risk
- Actual challenge and risk

2.9 - Finish Quality

- Completed bike park shall reflect professional workmanship in appearance, quality, and attention to detail. Trails and features shall be well integrated into site, aesthetically pleasing in appearance, and well-shaped, crafted, and finished according to commonly accepted best practices for high quality and sustainable mountain biking trails. Work must be completed to the satisfaction of the Owner's Representative.
- Contractor shall leave trails and adjacent areas in a finished and natural looking condition and minimize disturbance to permanent existing vegetation to the extent possible.

Wildwood Park Bid Sheet

Item No	Description	Est Quantity	Unit	Unit Price	Item Total
Miscellaneous					
1	Mobilization	1	LS		
Singletrack Trail Construction					
1	USFS Class 3, Bike Optimized Singletrack Trail (36" average width)	32,560	LF		
2	Boardwalk without handrail (615ft x 3ft)	1,845	SQ FT		
3	Traction enhancement for boardwalk decking	1845	SQ FT		
4	Imported 4" Thick Stone Trail Armoring	144	TN		
				Sub Total	
Pump Track Construction					
1	Site Preparation + Drainage	1	LS		
2	70/30 Clay/Sand Fill Material	875	CU YD		
3	Road Base Fill	80	CU YD		
4	Paved Riding Surface	3,958	SQ FT		
				Sub Total	

Wildwood Park Bid Sheet

Skills Park Construction					
1	40' Shipping Container with flood vents, anchors	2	LS		
2	20' Shipping Container with flood vents, anchors	1	LS		
3	70/30 Clay/Sand Fill Material	1200	CU YD		
4	Start area, container surfacing, handrails, drop, access ramp w/ retaining wall	1	LS		
5	Advance line constructed take off ramp, steel substructure rough sawn cedar finish, 6' tall	4	LS		
6	Intermediate line constructed take off ramp, steel substructure rough sawn cedar finish, 4' tall	4	LS		
7	Beginner line constructed take off ramp, steel substructure rough sawn cedar finish, 3' tall	4	LS		
				Sub Total	
Add Alternates					
1	Trex Decking upgrade to boardwalk	1,845	SQ FT		
2	Trail Carsonite Signage Posts	24	LS		
3	Trail Entrance Arch	1	LS		
4	Trail Map Kiosk	1	LS		
5	Pump Track & Skills Park Kiosk	1	LS		
6	Pump Track Skate park inspired features, bidder to provide description	2	LS		
7	Pump Track Curved Wall Ride, 30' Long	1	LS		
8	Advance skills line wall ride, 20' long	1	LS		
9	Push bike track (strider bike)	1	LS		
10	Live Edge Cedar Benches w/ Steel Frame	6	LS		
				Sub Total	
				Total	

LEGEND

- WILDWOOD HIGH GROUND LOOP
- WILDWOOD LOWLAND LOOP B
- WILDWOOD LOWLAND LOOP C
- WILDWOOD GREENWAY
- WILDWOOD EAST LOOP
- BOARDWALK
- WILDWOOD LOWLAND LOOP A
- CONTOUR BELOW 6FT
- CONTOUR ABOVE 6FT
- SKILLS / PUMP TRACK
- DELINEATED WETLANDS

WILDWOOD PARK SINGLETRACK ESTIMATED QUANTITIES

Singletrack Trail Construction	Description	Est Quantity	Unit
1	USFS Class 3, Bike Optimized Singletrack Trail (36" average width)	31,700	LF
2	Boardwalk without handrail (615ft x 3ft)	1,845	SQ FT
3	Traction enhancement for boardwalk decking	1845	SQ FT
4	Imported 4" Thick Stone Trail Armoring	144	TN

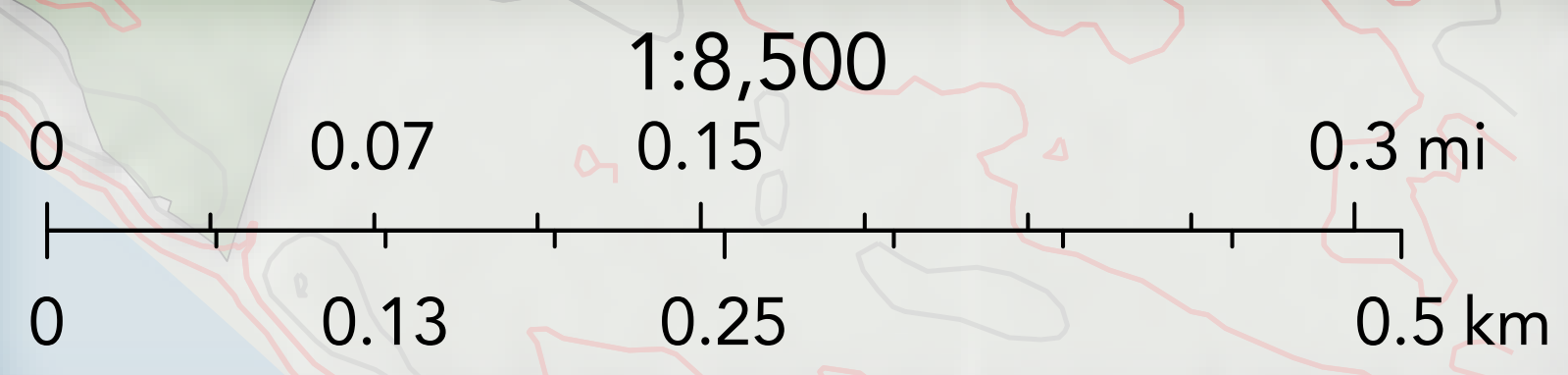
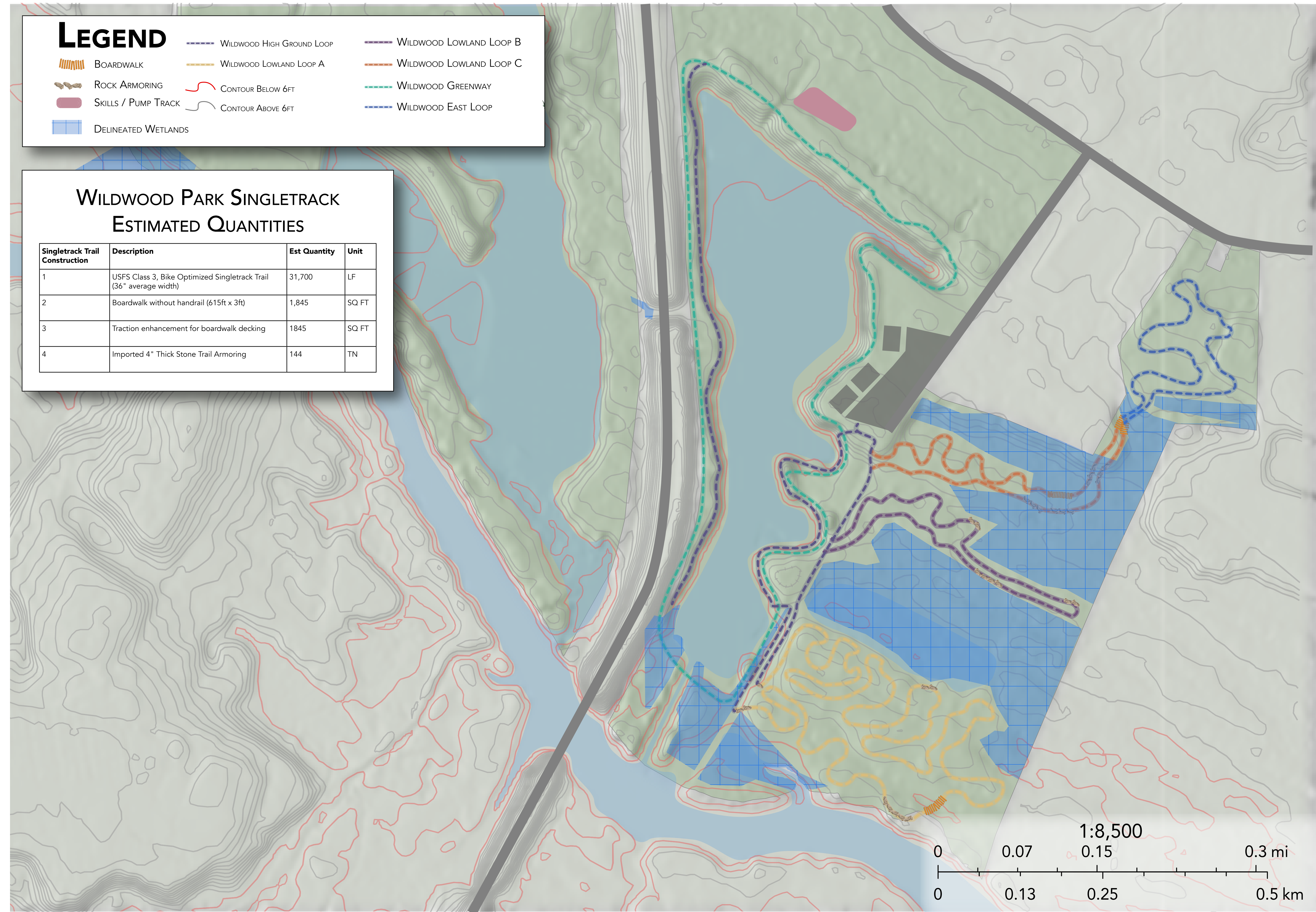

DATE
02/17/2022

REVISION

- 1: INITIAL RELEASE 02/11/22
- 2: UPDATE SKILLS PARK LOCATION, ADDITION DETAILS 02/17/22
- 3: UPDATED HIGH GROUND LOOP ALIGNMENT 03/10/22
- 4: UPDATED TOTAL LN FT TO 31,700 FROM 32,560 03/15/2022



CONSERVATION THROUGH RECREATION
Chapel Hill NC • Brevard NC • Salt Lake City, UT
11312 US Hwy 15 S01 N, #107185
Chapel Hill, NC 27517

WILDWOOD PARK MOUNTAIN BIKE TRAILS

TRAIL PLAN

Sheet Number

1

GENERAL TRAIL CONSTRUCTION NOTES

- TRAIL CONSTRUCTION SHALL ADHERE TO THE IMBA STANDARDS AS SPECIFIED IN THEIR BOOK, *TRAIL SOLUTIONS*.
- OVERALL TRAIL CHARACTERISTICS SHALL RESEMBLE A USFS TRAIL CLASS 3.
- ALL TRAIL CONSTRUCTION SHALL HAVE A 24-36" FINISHED TREAD WIDTH.
- ALL MAIN TRAIL CONSTRUCTION BI-DIRECTIONAL COMPATIBLE.
- NO TRAIL SECTION SHALL BE OVER 50% OF FALL LINE GRADE.
- GRADE REVERSALS OR DRAINS SHALL BE INSTALLED EVERY 25'-30'.
- MAXIMUM SIDE SLOPE OF TRAIL SHOULD BE TREAD 8% FOR ANY DISTANCE OVER 10'.
- TRAIL BED MUST BE COMPACTED WITH VIBRATORY COMPACTOR.
- RE-NATURALIZED DISTURBANCES, SPOILS, AND BORROW PITS WITH NATIVE ORGANICS.
- BACK-SLOPE AND CONSTRUCTED FEATURE ANGLE OF REPOSE NO GREATER THAN 1:1.
- 6" MAXIMUM DIAMETER BREAST HEIGHT (DBH) TREE REMOVAL IN TRAIL CORRIDOR
- PROTECT MATURE TREE ROOT BALLS WITH REDUCED TREAD WIDTH OR FILL CAP
- 6' MINIMUM TRAIL CORRIDOR
- 10' CORRIDOR CENTERLINE ALLOWANCE, LEFT OR RIGHT OF FLAG LINE
- MAINTAIN LESS THAN 1,500 SQ FT OF UNCOMPACTED SOIL AT ANY TIME
- BORROW PITS CAN BE UTILIZED AT NO LESS THAN 30' INTERVALS ALONG THE TRAIL UNLESS NEEDED FOR A CONSTRUCTED FEATURE
- ALL BORROW PITS MUST BE CLOSED AND CAPPED WITH ORGANIC MATERIAL
- BORROW PITS SHOULD BE UTILIZED FOR DRAINAGE IN FLAT SECTIONS OF TRAIL
- ALL BENCH CUT MUST BE FULL BENCH CONSTRUCTION WITH NO ORGANIC FILL BELOW MINERAL SPOILS.

FIGURE 1
TRAIL CLEARING LIMITS

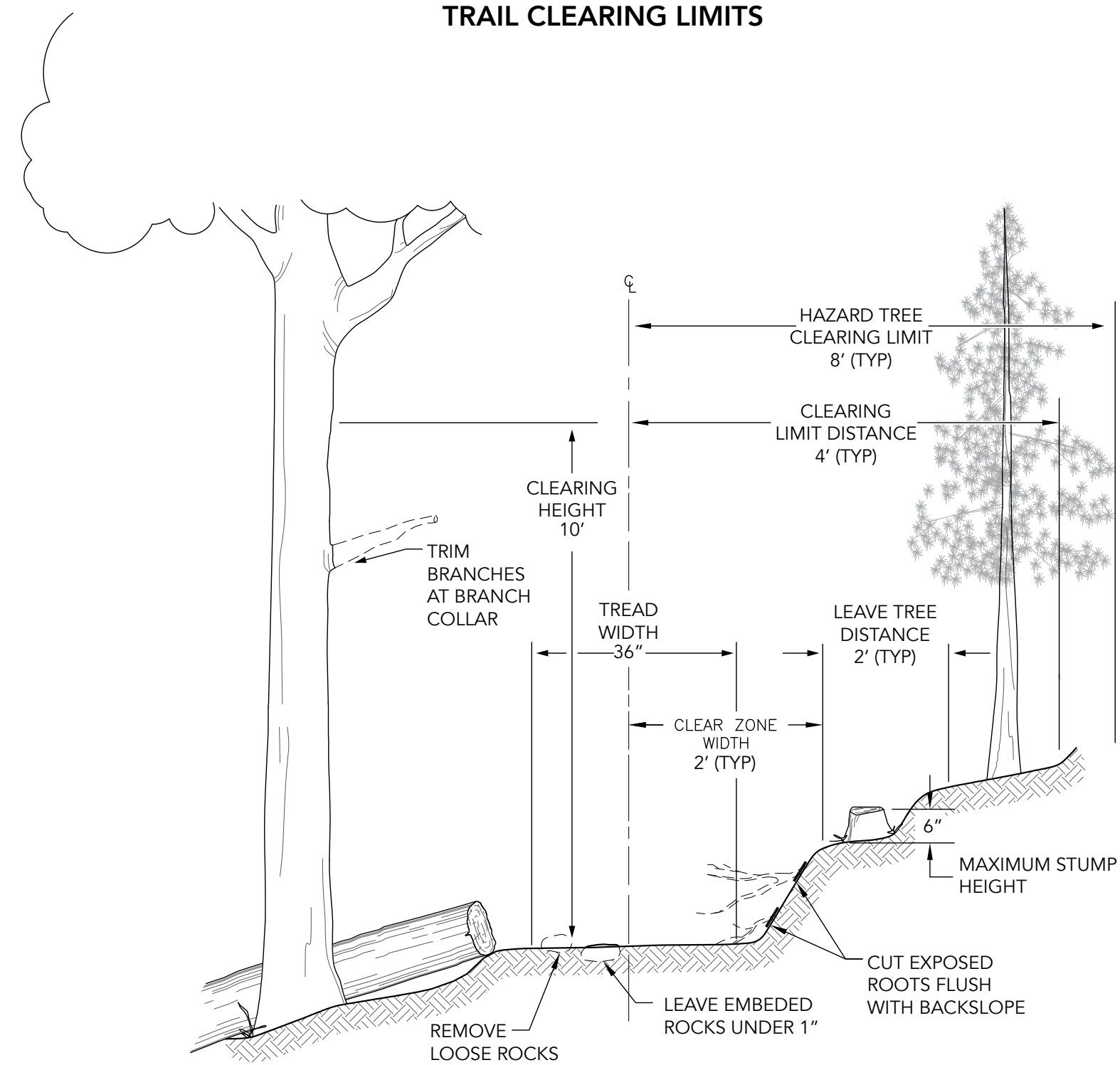
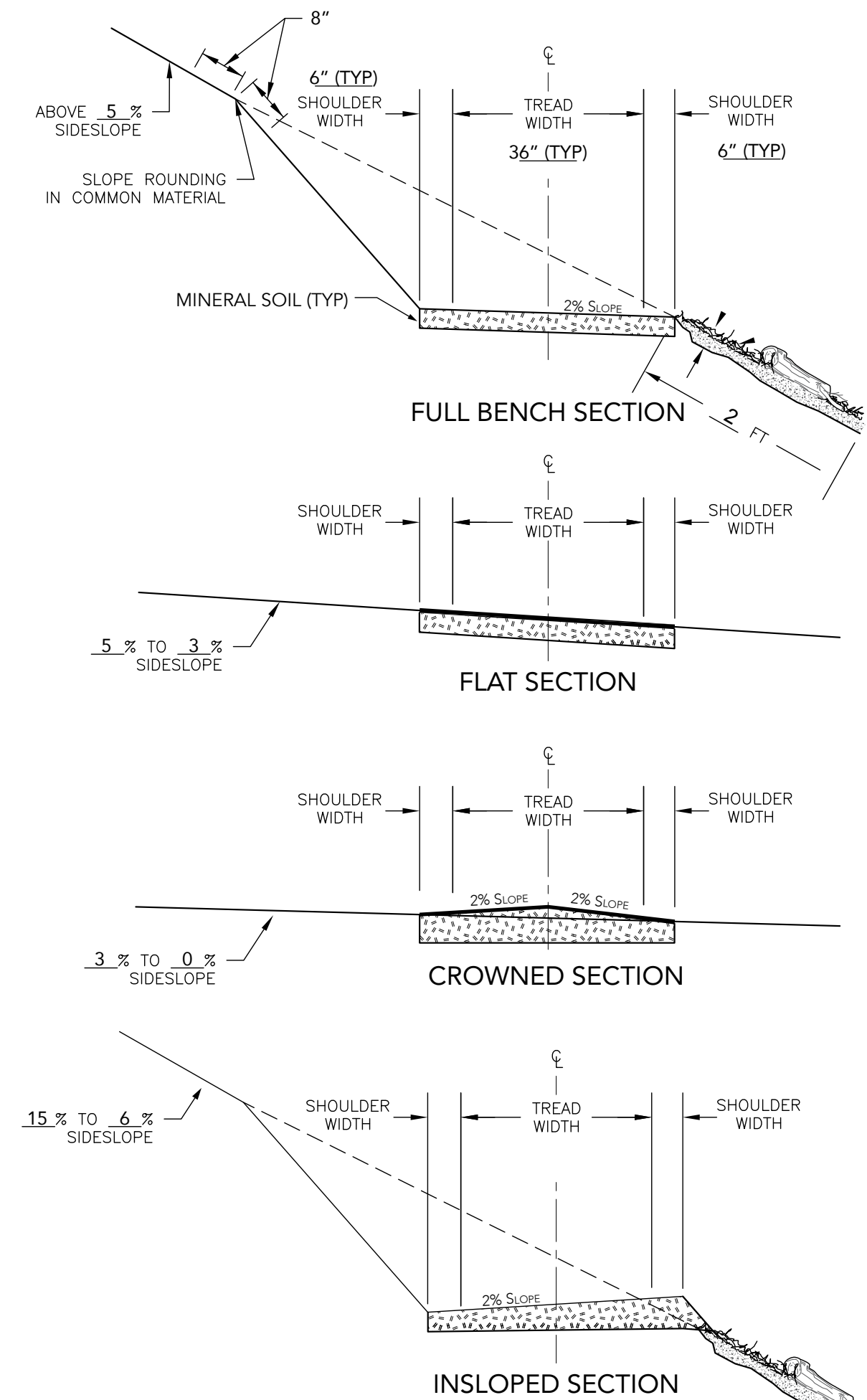

FIGURE 2
TYPICAL TRAIL CROSS SECTIONS



TRAILBED AND SLOPE FINISH

FINISH SLOPE
REMOVE ALL ROOTS AND LOOSE ROCKS FROM THE SLOPE. RE-NATURALIZE ANY DISTURBED GROUND WITH SLASH.

TRAIL SURFACE FINISH
TRAIL SURFACE FINISH SHALL CONSIST OF MINERAL SOIL VOID OF ANY ORGANIC MATERIAL

TRAIL BED FINISH
REMOVE LOOSE ROCK ON THE TRAIL BED WITH A DIMENSION GREATER THAN 2\"/>

- NOTES:
1. SLASH CONSISTS OF LOGS, LIMBS, BRUSH, AND ROCKS PLACED RANDOMLY IN A WAY TO CATCH SEDIMENT MOVEMENT.
 2. LIMB ALL TREES AND SHRUBS AND TAMP SLASH INTO GROUND SO THAT 80% OF SLASH IS IN CONTACT WITH THE GROUND.

FIGURE 3
TYPICAL GRADE REVERSAL

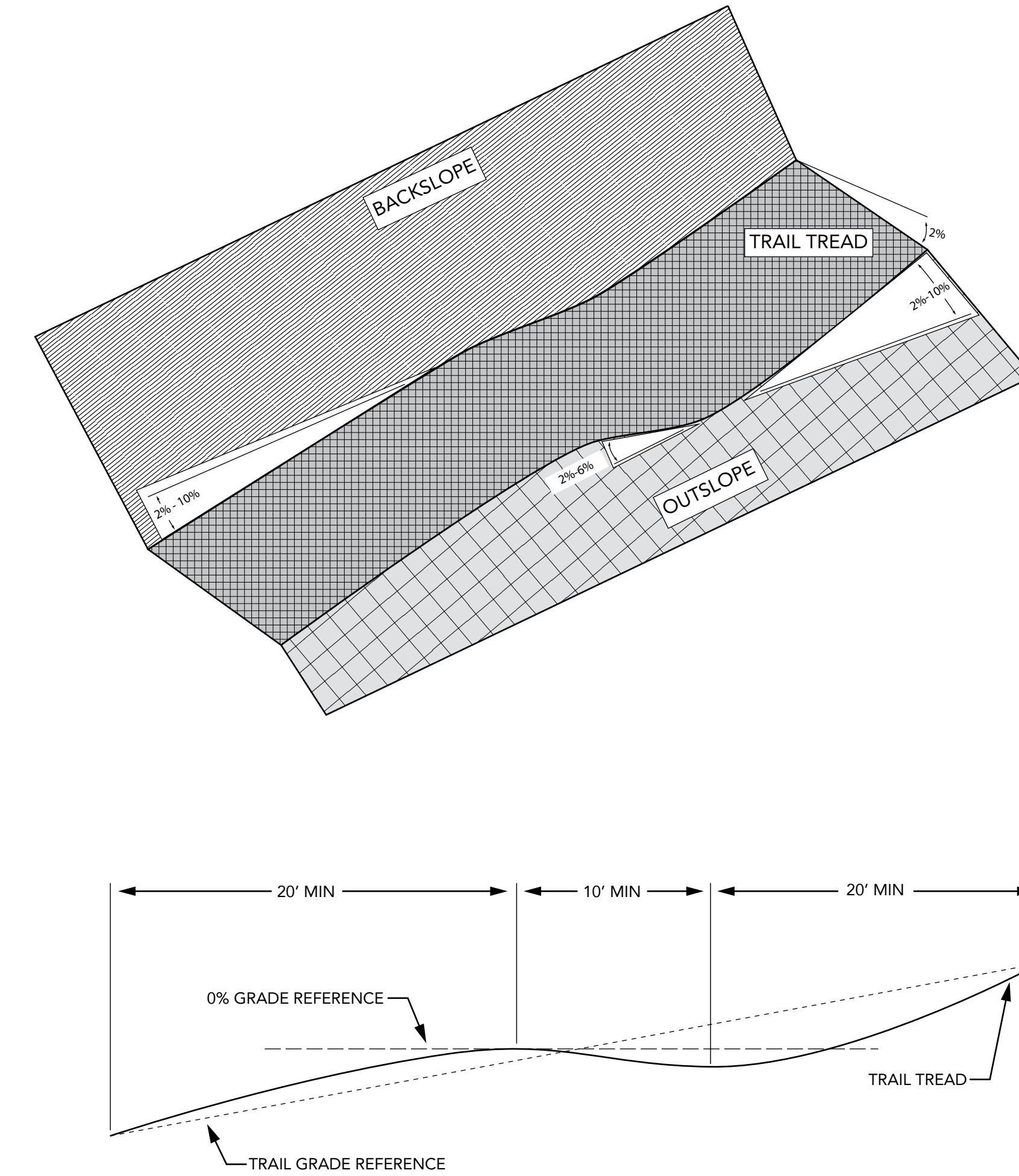

TRAIL GRADE REVERSAL

TRAIL GRADE REVERSALS SHALL BE PLACED ON ANY STRAIGHT SECTION OF TRAIL WHERE NATURAL GRADE REVERSALS ARE UNCOMMON.

THE DIP SHALL BE OUTSLOPED TO TWICE OF THE SIDE SLOPE OF THE TRAIL TREAD

DATE
02/17/2022

REVISION

- 1: INITIAL RELEASE 02/11/22
- 2: UPDATE SKILLS PARK LOCATION, ADDITION DETAILS 02/17/22
- 3: UPDATED HIGH GROUND LOOP ALIGNMENT 03/10/22
- 4: UPDATED TOTAL LN FT TO 31,700 FROM 32,560 03/15/2022



CONSERVATION THROUGH RECREATION
Chapel Hill NC • Brevard NC • Salt Lake City, UT
11312 US Hwy 15 S01 N. #107185
Chapel Hill, NC 27517

WILDWOOD PARK
MOUNTAIN BIKE TRAILS

TRAIL DETAIL

Sheet Number

2

HIGH GROUND TRAIL CONSTRUCTION NOTES

TRAIL TYPE: SINGLE TRACK BIKE OPTIMIZED
TRAIL DIFFICULTY RATING: GREEN / BEGINNER FRIENDLY
TRAIL LENGTH: 8,250 FT
TRAIL FLAGGING COLOR: ORANGE

TYPICAL TREAD WIDTH: 36"
TYPICAL CORRIDOR WIDTH: 72"

TREAD PROTRUSIONS: CONSTANT SURFACE, SOME ROOTS, ROCKS OR OTHER PROTRUSIONS LESS THAN 6". PROTRUSIONS SHOULD NOT BE CLOSER THAN 12" TOGETHER.

MAXIMUM TREAD GRADE: 10%
TYPICAL TREAD MATERIAL: COMPACTED NATIVE MINERAL SOIL FREE OF ORGANIC MATERIAL. TRAIL TREAD TO BE CONSTRUCTED OF UNDISTURBED MINERAL MATERIAL WHENEVER POSSIBLE.

INTENDED EXPERIENCE: THE HIGH GROUND TRAIL IS DESIGNED TO BE THE MAIN LOOP IN THE WILDWOOD PARK SYSTEM. THIS IS DESIGNED AT A HIGHER ELEVATION TO ALLOW FOR IT TO BE ACCESSIBLE DURING HIGH WATER EVENTS THAT WOULD FLOOD THE LOWLAND TRAILS.

THIS TRAIL WILL SHARE SMALL SECTIONS WITH THE GREENWAY TRAIL. THESE SECTIONS OF SHARED TRAIL WILL BE KEPT TO A MINIMUM TO LIMIT USER CONFLICTS.

THIS TRAIL SHOULD BE ACCESSIBLE TO ALL USERS

TYPICAL TRAIL CROSS SECTION

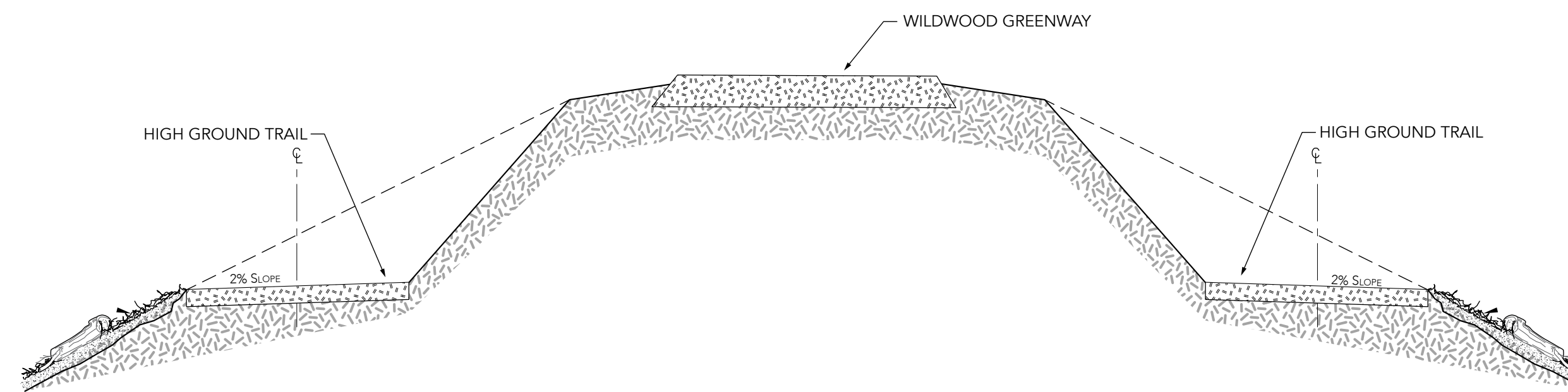

TYPICAL TRAIL



TYPICAL TRAIL BENCH CUT

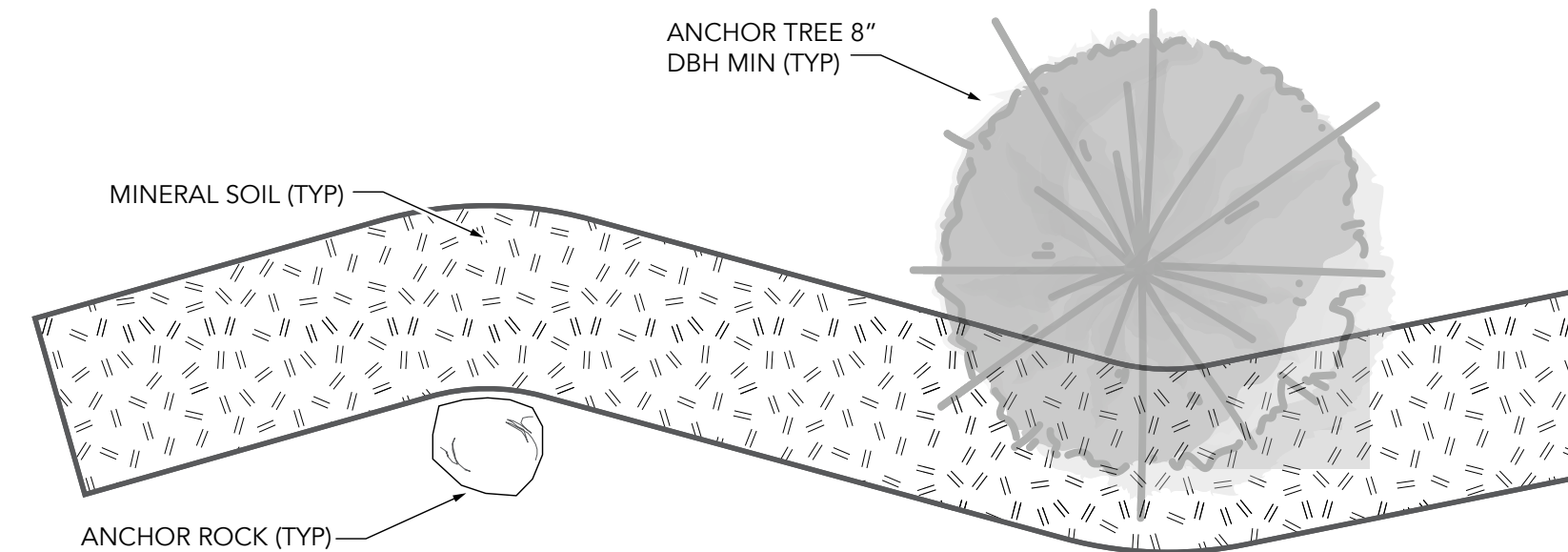

DATE	REVISION
02/17/2022	
	1: INITIAL RELEASE 02/11/22
	2: UPDATE SKILLS PARK LOCATION, ADDITION DETAILS 02/17/22
	3: UPDATED HIGH GROUND LOOP ALIGNMENT 03/10/22
	4: UPDATED TOTAL LN FT TO 31,700 FROM 32,560 03/15/2022

CONSERVATION THROUGH RECREATION
 Chapel Hill NC • Brevard NC • Salt Lake City UT
 11312 US Hwy 15 S01 N • #107185
 Chapel Hill, NC 27517

**WILDWOOD PARK
 MOUNTAIN BIKE TRAILS**

TRAIL DETAIL

LOWLAND LOOP A CONSTRUCTION NOTES

TRAIL TYPE: SINGLE TRACK BIKE OPTIMIZED
TRAIL DIFFICULTY RATING: BLUE / INTERMEDIATE
TRAIL LENGTH: 9,800 FT
BOARDWALK LENGTH: 90 FT
ROCK ARMORING LENGTH: 525 FT
TRAIL FLAGGING COLOR: PINK

TYPICAL TREAD WIDTH: 36"
TYPICAL CORRIDOR WIDTH: 72"
TREAD PROTRUSIONS: CONSTANT SURFACE, SOME ROOTS, ROCKS OR OTHER PROTRUSIONS LESS THAN 10". PROTRUSIONS CAN BE CLOSE TOGETHER.
MAXIMUM TREAD GRADE: N/A
TYPICAL TREAD MATERIAL: COMPACTED NATIVE MINERAL SOIL FREE OF ORGANIC MATERIAL.

INTENDED EXPERIENCE: THE LOWLAND LOOP A TRAIL IS DESIGNED TO BE ONE OF THE STACKED LOOPS IN THE WILDWOOD PARK SYSTEM. IT SHOULD MAINTAIN A CONSTANT FLOW WITH MINIMAL INTERRUPTIONS BUT SPEED CAN BE CONTROLLED IN THIS SECTION

THIS TRAIL IS AT A LOWER ELEVATION THAN THE HIGH GROUND LOOP, (6' MSL TO 10' MSL). THIS TRAIL REQUIRES CONSTRUCTION TECHNIQUES THAT CAN BE FREQUENTLY SUBMERGED AND REMAIN IN PLACE WHEN THE WATER RECEDES.

SIGNATURE FEATURE: THE LOWLAND LOOP A WILL PASS THROUGH SOME OF THE UNIQUE SWAMP ECOSYSTEMS OF THE PARK. THIS SIGNATURE FEATURE WILL BE A BOARDWALK THAT TAKES THE USER PAST THE LARGE DIAMETER TREES IN THESE PHOTOS



LOWLAND LOOP B CONSTRUCTION NOTES

TRAIL TYPE: SINGLE TRACK BIKE OPTIMIZED
TRAIL DIFFICULTY RATING: BLUE / INTERMEDIATE
TRAIL LENGTH: 4,600 FT
ROCK ARMORING LENGTH: 220 FT
TRAIL FLAGGING COLOR: PINK

TYPICAL TREAD WIDTH: 36"
TYPICAL CORRIDOR WIDTH: 72"
TREAD PROTRUSIONS: CONSTANT SURFACE, SOME ROOTS, ROCKS OR OTHER PROTRUSIONS LESS THAN 10". PROTRUSIONS CAN BE CLOSE TOGETHER.
MAXIMUM TREAD GRADE: N/A
TYPICAL TREAD MATERIAL: COMPACTED NATIVE MINERAL SOIL FREE OF ORGANIC MATERIAL.

INTENDED EXPERIENCE: THE LOWLAND LOOP B TRAIL IS DESIGNED TO BE ONE OF THE STACKED LOOPS IN THE WILDWOOD PARK SYSTEM. IT SHOULD MAINTAIN A CONSTANT FLOW WITH MINIMAL INTERRUPTIONS BUT SPEED CAN BE CONTROLLED IN THIS SECTION

THIS TRAIL IS AT A LOWER ELEVATION THAN THE HIGH GROUND LOOP, (6' MSL TO 10' MSL). THIS TRAIL REQUIRES CONSTRUCTION TECHNIQUES THAT CAN BE FREQUENTLY SUBMERGED AND REMAIN IN PLACE WHEN THE WATER RECEDES.

SIGNATURE FEATURE: THERE ARE MORE PERSISTENTLY LOW ELEVATIONS ON THIS TRAIL THAT WILL REQUIRE ROCK ARMORING TO MAINTAIN THE TRAIL TREAD. THE MAIN LINE SHOULD BE CONSTRUCTED TO AN INTERMEDIATE SKILL LEVEL. ROCKS CAN BE OFFSET BY UP TO 6" VERTICALLY IN A GIVEN SECTION.

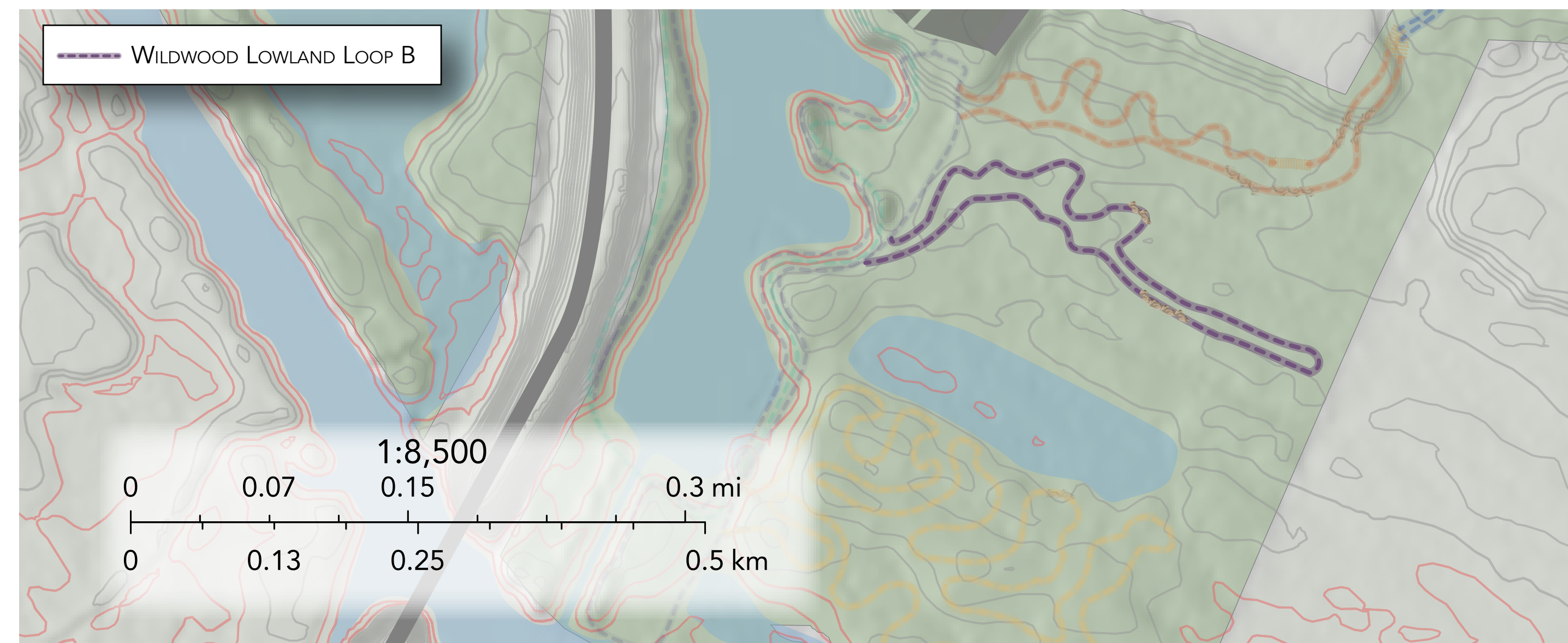

DATE
 02/17/2022

REVISION

- 1: INITIAL RELEASE 02/11/22
- 2: UPDATE SKILLS PARK LOCATION, ADDITION DETAILS 02/17/22
- 3: UPDATED HIGH GROUND LOOP ALIGNMENT 03/10/22
- 4: UPDATED TOTAL LN FT TO 31,700 FROM 32,560 03/15/2022



CONSERVATION THROUGH RECREATION
 Chapel Hill NC • Brevard NC • Salt Lake City UT
 11312 US Hwy 15 501 N. #107185
 Chapel Hill, NC 27517

WILDWOOD PARK
 MOUNTAIN BIKE TRAILS

TRAIL DETAIL

Sheet Number

4

LOWLAND LOOP C CONSTRUCTION NOTES

TRAIL TYPE: SINGLE TRACK BIKE OPTIMIZED
TRAIL DIFFICULTY RATING: BLUE / INTERMEDIATE
TRAIL LENGTH: 4,360 FT
WETLAND IMPACT: 2,400 SQ FT
BOARDWALK LENGTH: 525 FT
ROCK ARMORING LENGTH: 320 FT
TRAIL FLAGGING COLOR: PINK

TYPICAL TREAD WIDTH: 36"
WETLAND TREAD WIDTH: 24"
TYPICAL CORRIDOR WIDTH: 72"
TREAD PROTRUSIONS: CONSTANT SURFACE, SOME ROOTS, ROCKS OR OTHER PROTRUSIONS LESS THAN 10". PROTRUSIONS CAN BE CLOSE TOGETHER.
MAXIMUM TREAD GRADE: N/A
TYPICAL TREAD MATERIAL: COMPACTED NATIVE MINERAL SOIL FREE OF ORGANIC MATERIAL.

INTENDED EXPERIENCE: THE LOWLAND LOOP C TRAIL IS DESIGNED TO BE ONE OF THE STACKED LOOPS IN THE WILDWOOD PARK SYSTEM. IT SHOULD MAINTAIN A CONSTANT FLOW WITH MINIMAL INTERRUPTIONS BUT SPEED CAN BE CONTROLLED IN SECTION

THIS TRAIL IS AT A LOWER ELEVATION THEN THE HIGH GROUND LOOP, (6' MSL TO 8' MSL). THIS TRAIL REQUIRES CONSTRUCTION TECHNIQUES THAT CAN BE FREQUENTLY SUBMERGED AND REMAIN IN PLACE WHEN THE WATER RECEDES.

WETLAND TREAD: WHEN THE TRAIL IS CONSTRUCTED IN DELINEATED WETLANDS THE TRAIL WIDTH IS NARROWED TO 24". ALL PRECAUTIONS MUST BE TAKEN TO MINIMIZE CONSTRUCTION IMPACT TO THE DEFINED TREAD WITHIN THESE SECTIONS.

SIGNATURE FEATURE: THE LOWLAND LOOP C WILL PASS THROUGH DELINEATED WETLANDS. THIS WILL BE AN OPPORTUNITY TO CONSTRUCT BOTH BOARDWALKS AND ROCK ARMORED TURNPIKES THAT WILL PASS THOUGH PERSISTENTLY WET AREAS.

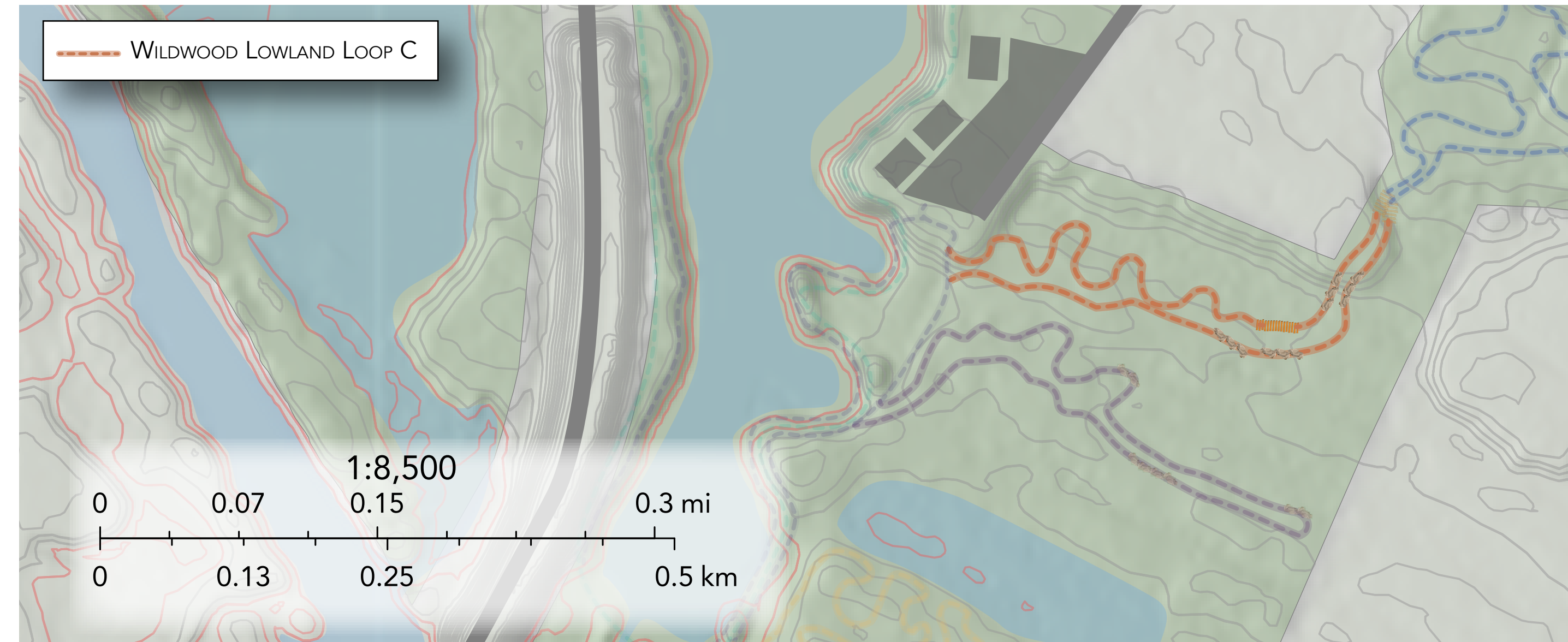

EAST LOOP CONSTRUCTION NOTES

TRAIL TYPE: SINGLE TRACK BIKE OPTIMIZED
TRAIL DIFFICULTY RATING: BLUE / INTERMEDIATE
TRAIL LENGTH: 3,700 FT
WETLAND IMPACT: 525 SQ FT
BOARDWALK / BRIDGE LENGTH: 150 FT
TRAIL FLAGGING COLOR: PINK

TYPICAL TREAD WIDTH: 36"
WETLAND TREAD WIDTH: 36"
TYPICAL CORRIDOR WIDTH: 72"
TREAD PROTRUSIONS: CONSTANT SURFACE, SOME ROOTS, ROCKS OR OTHER PROTRUSIONS LESS THAN 10". PROTRUSIONS CAN BE CLOSE TOGETHER.
MAXIMUM TREAD GRADE: N/A
TYPICAL TREAD MATERIAL: COMPACTED NATIVE MINERAL SOIL FREE OF ORGANIC MATERIAL.

INTENDED EXPERIENCE: THE EAST LOOP IS DESIGNED TO BE ONE OF THE STACKED LOOPS IN THE WILDWOOD PARK SYSTEM. IT SHOULD MAINTAIN A CONSTANT FLOW WITH MINIMAL INTERRUPTIONS BUT SPEED CAN BE CONTROLLED IN THIS SECTION.

THIS TRAIL IS AT A HIGHER ELEVATION THAN THE LOWLAND LOOPS, (14' MSL TO 22' MSL). THIS TRAIL REQUIRES STABILIZATION OF THE SANDY SOIL. THIS CAN BE DONE THOUGH ROCK ARMORING OR POSSIBLE CAPPING WITH MINERAL SOIL FROM BORROW PITS.

SIGNATURE FEATURE: THIS AREA IS THE LEAST LIKELY TO BE INUNDATED AND IS BEST SUITED FOR CONSTRUCTED FEATURES ON THE TRAIL.

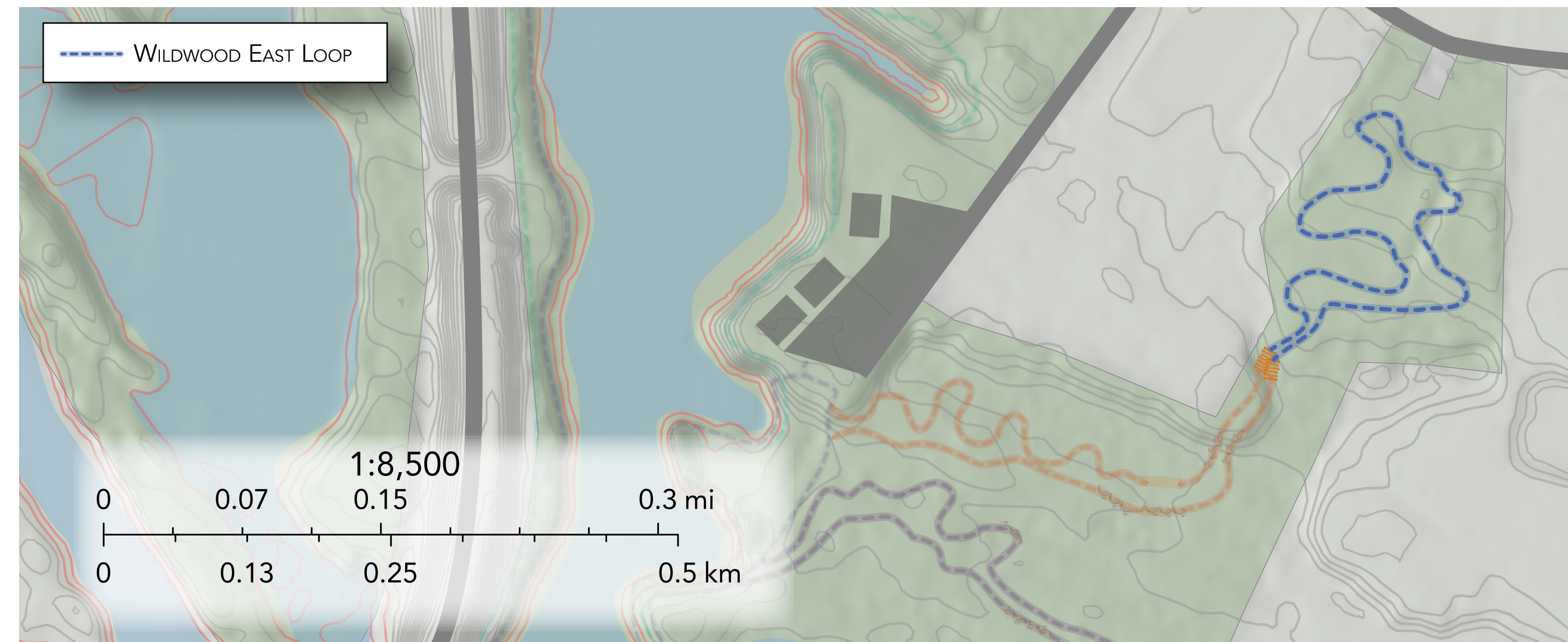

DATE
 02/17/2022

REVISION

- 1: INITIAL RELEASE 02/11/22
- 2: UPDATE SKILLS PARK LOCATION, ADDITION DETAILS 02/17/22
- 3: UPDATE HIGH GROUND LOOP ALIGNMENT 03/10/22
- 4: UPDATED TOTAL LN FT TO 31,700 FROM 32,560 03/15/2022



CONSERVATION THROUGH RECREATION
 Chapel Hill NC • Brevard NC • Salt Lake City UT
 11312 US Hwy 15 S01 N • #107185
 Chapel Hill, NC 27517

WILDWOOD PARK
 MOUNTAIN BIKE TRAILS

TRAIL DETAIL

Sheet Number

5

WETLAND DISTURBANCE

DISTURBANCE TYPE: SINGLE TRACK MOUNTAIN BIKE TRAIL CONSTRUCTION

ESTIMATED LOOP C DISTURBANCE: 2,400 SQ FT

ESTIMATED EAST LOOP DISTURBANCE: 525 SQ FT

ESTIMATED TOTAL DISTURBANCE: 2925 SQ FT / .067 ACRE

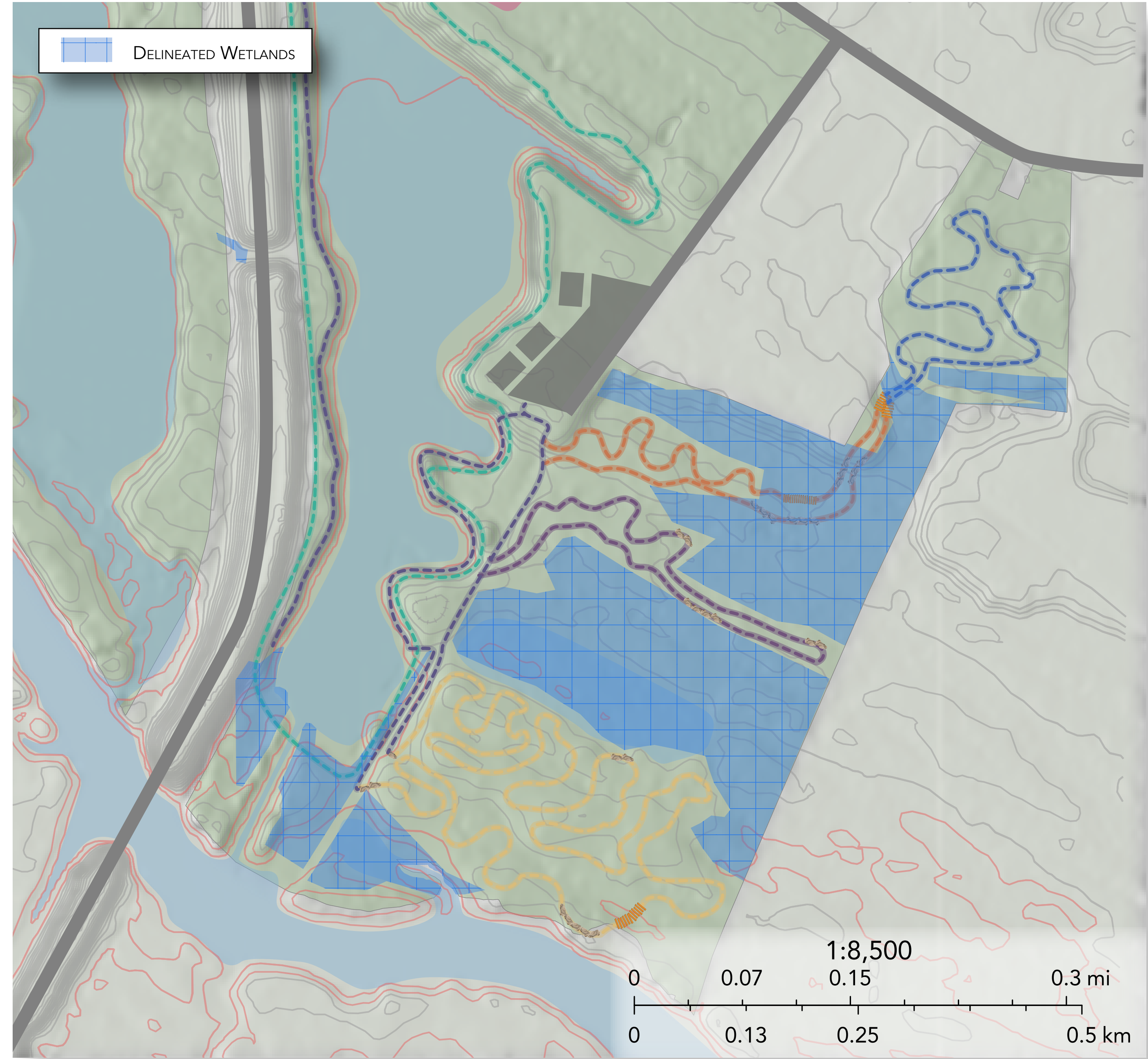

DATE
02/17/2022

REVISION

- 1: INITIAL RELEASE 02/11/22
- 2: UPDATE SKILLS PARK LOCATION, ADDITION DETAILS 02/17/22
- 3: UPDATED HIGH GROUND LOOP ALIGNMENT 03/10/22
- 4: UPDATED TOTAL LN FT TO 31,700 FROM 32,560 03/15/2022



CONSERVATION THROUGH RECREATION
Chapel Hill NC • Brevard NC • Salt Lake City, UT
11312 US Hwy 15 S01 N, #107185
Chapel Hill, NC 27517

WILDWOOD PARK
MOUNTAIN BIKE TRAILS
WETLAND DISTURBANCE

Sheet Number

6

BOARDWALK AND STONE ARMOR CONSTRUCTION

STRUCTURE NUMBER	BOARDWALK LENGTH	BOARDWALK CLEAR WIDTH	STRINGERS				DECK				HEADWALL				
			SPECIES	NUMBER	SIZE	TREATMENT	SPECIES	SIZE	TREATMENT	HARDWARE	SPECIES	SIZE	WIDTH	DEPTH	TREATMENT
		48"	SOUTHERN PINE	3	2" X 8" X 10'	MARINE GRADE PT	SOUTHERN PINE	2" X 6" X 36"	PT, AMERICAN SAFETY TECHNOLOGIES AS-175	MARINE GRADE STAINLESS	SOUTHERN PINE	2" X 10"	36"	20" MIN	GROUND CONTACT PT

STRUCTURE NUMBER	RAILING SYSTEM			SILL				APPROACHES				COMMENTS
	SPECIES	HEIGHT	TREATMENT	SPECIES	SIZE	WIDTH	TREATMENT	LENGTH	WIDTH	MATERIAL	DEPTH	
	EASTERN RED CEDAR	36"	OIL BASED DECK STAIN	RAILROAD TIE OR 8X8 TIMBER	7" X 9"	42"	CREOSOTE OR MARINE GRADE PT	4'	36"	MINERAL SOIL	24"	TREX COMPOSITE DECKING W/ TREX UNIVERSAL FASTENER OPTIONAL BID ITEM

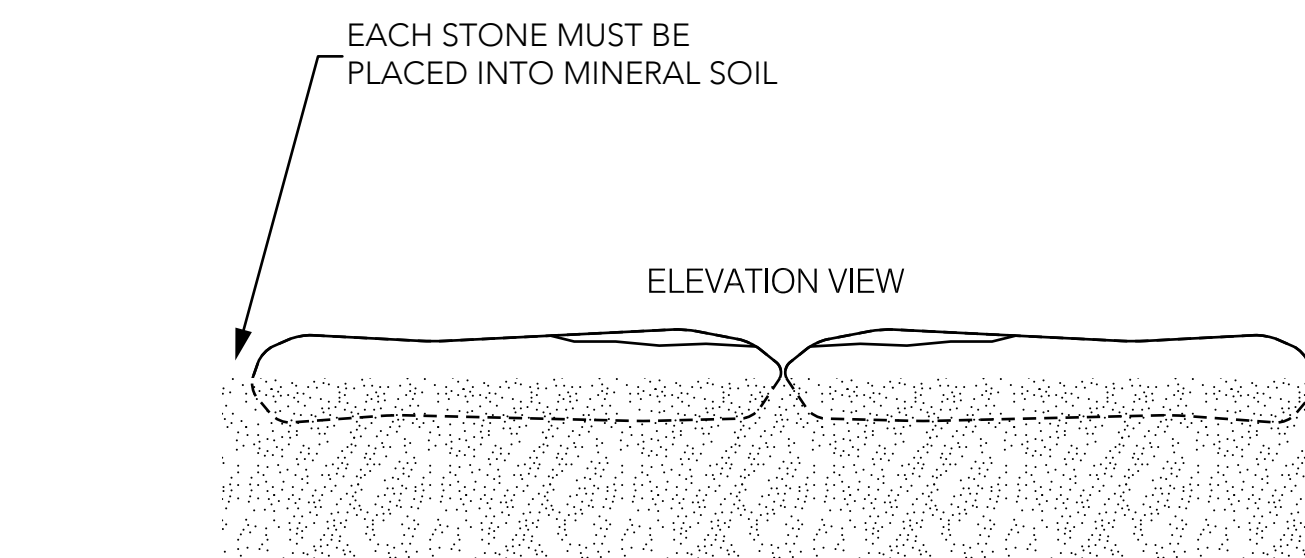
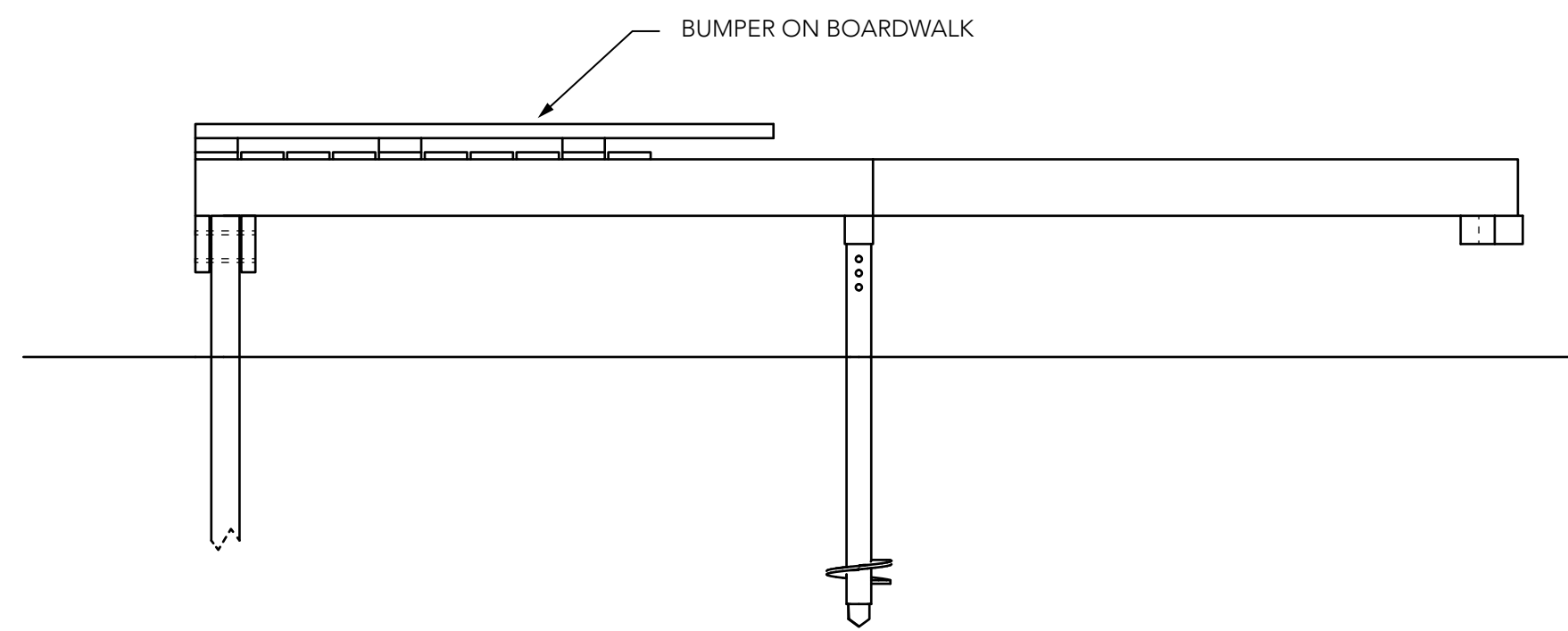
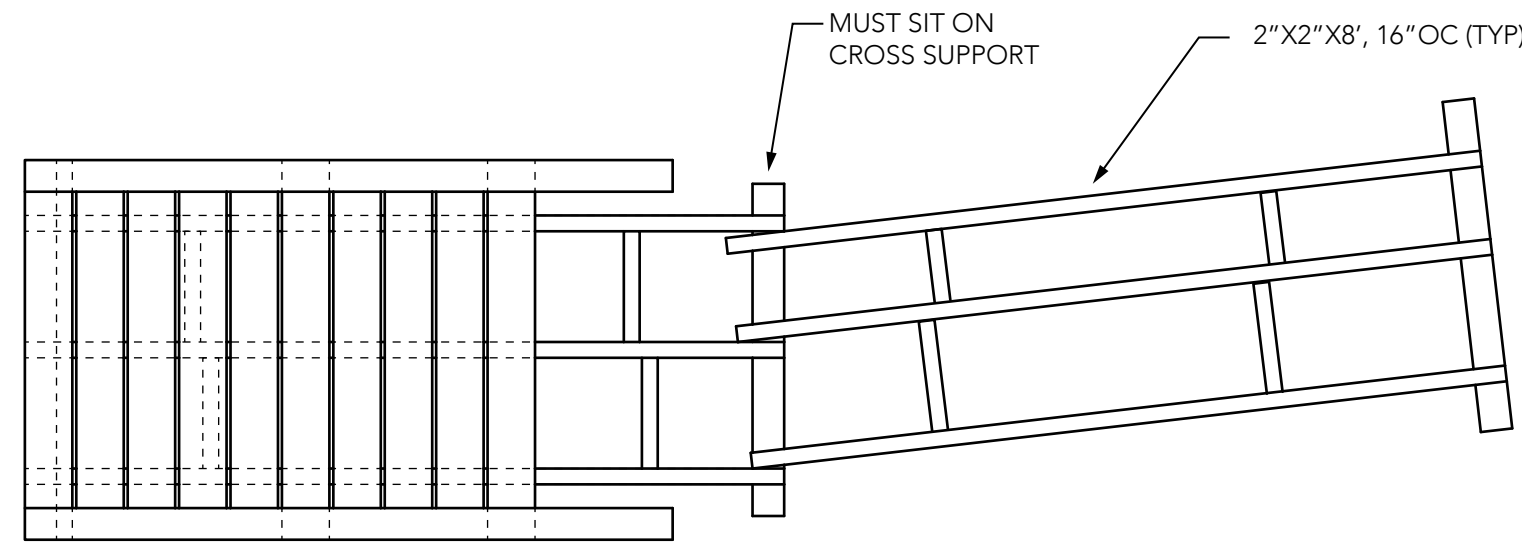
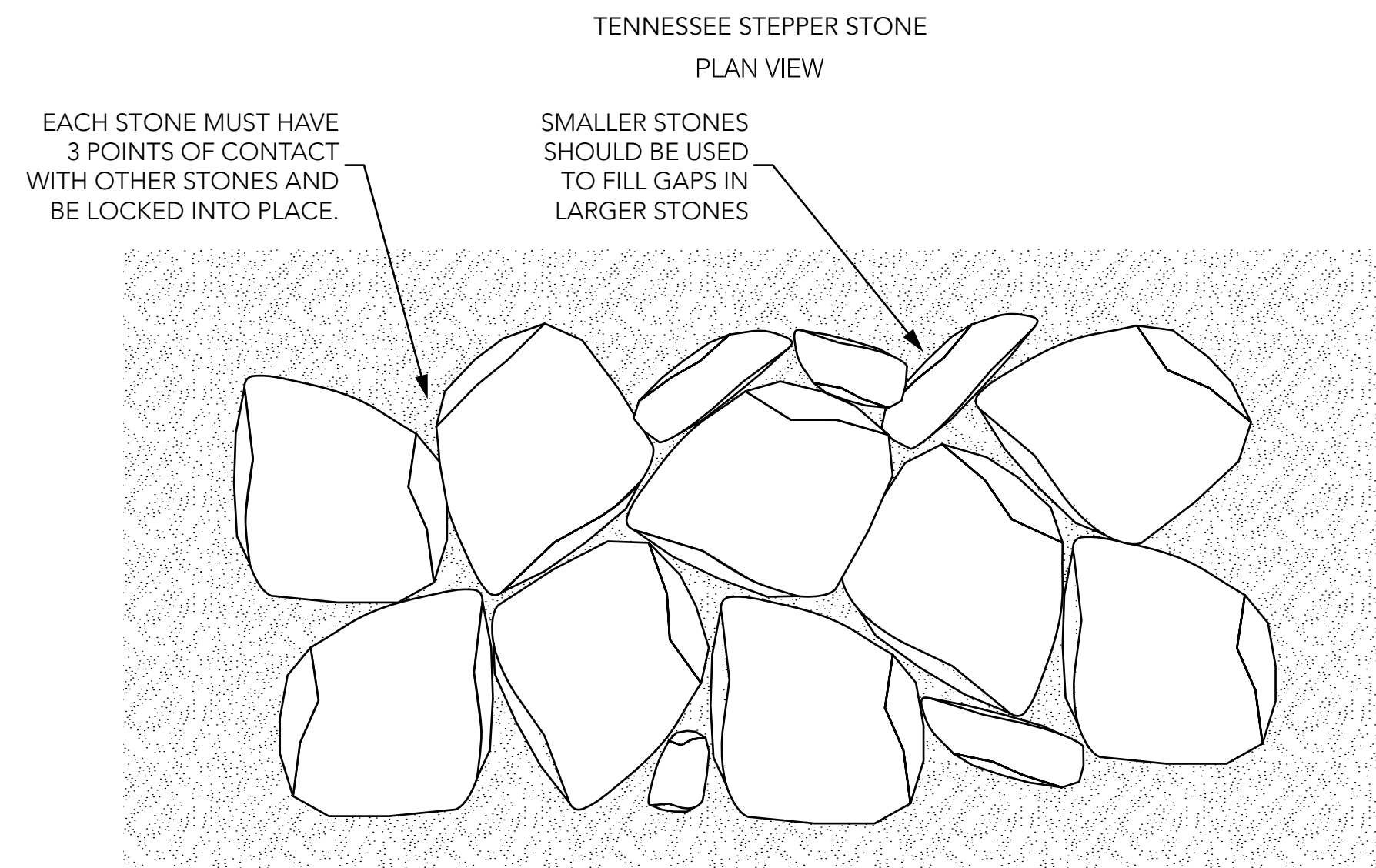
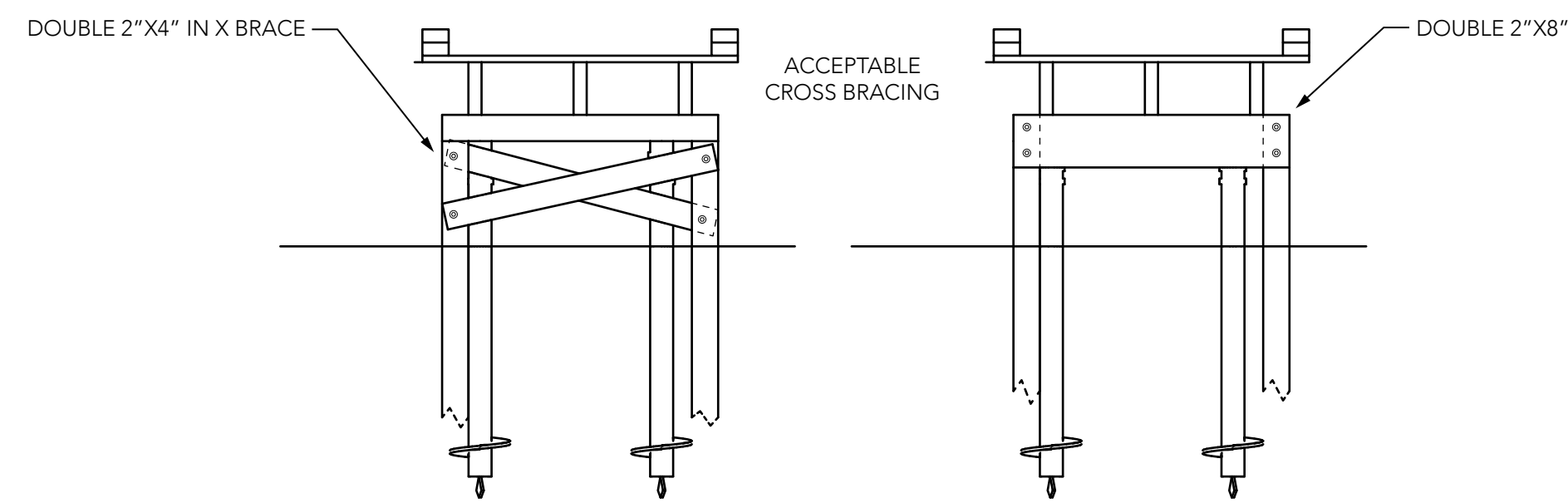
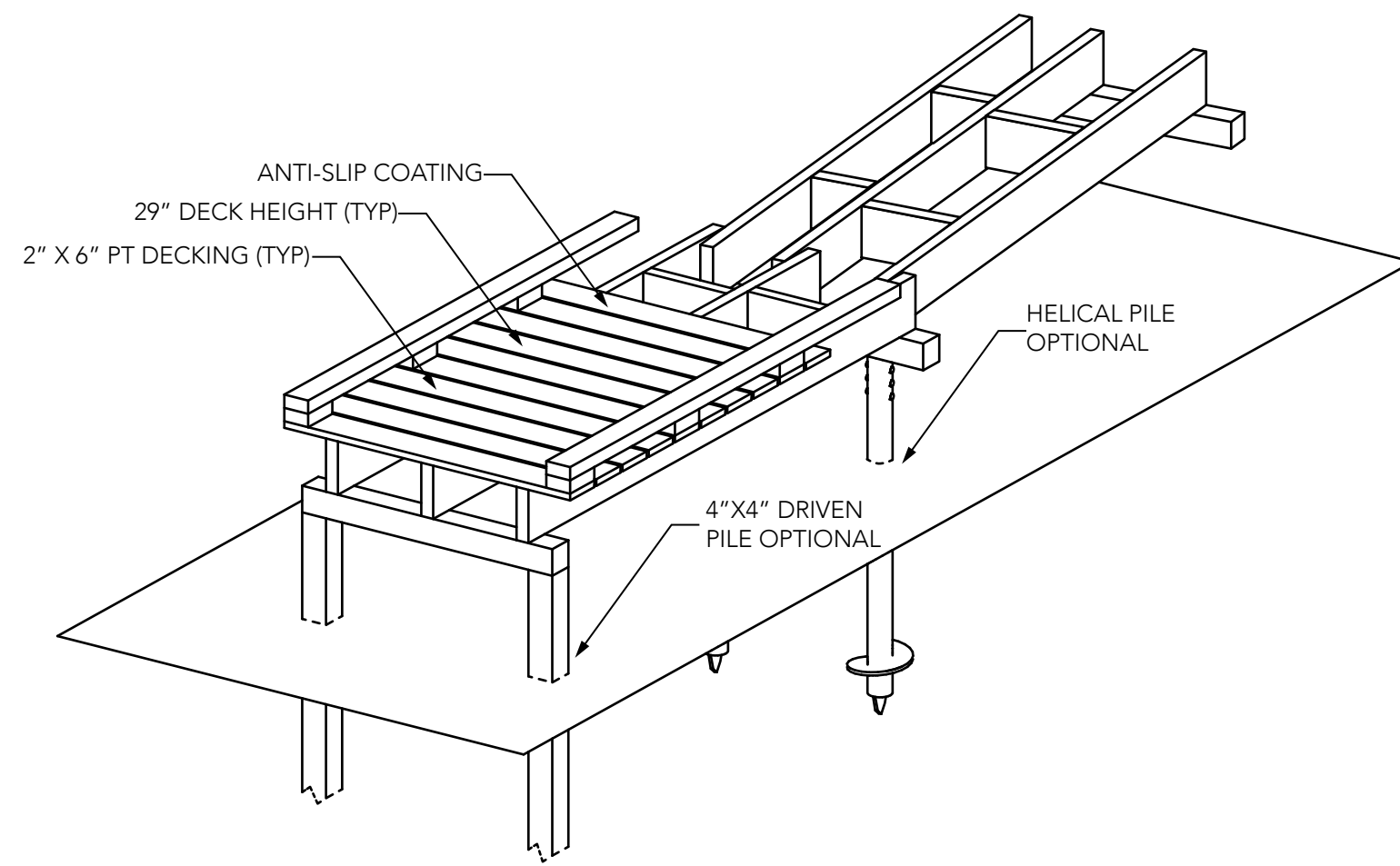

GENERAL NOTES:

TIMBER & LUMBER: SOLID SAWN TIMBER MEMBERS SHALL CONFORM TO THE REQUIREMENTS OF THE GRADING RULES AGENCY FOR THE SPECIES, TYPE, AND GRADE SPECIFIED BELOW

- **DECK PLANKS:** DECK PLANKS SHALL BE 2"X6" MARINE GRADE PRESSURE TREATED WITH AN OPTION OF 5/4" TREX COMPOSITE DECKING OR COMPARABLE PRODUCT AS APPROVED
- **ANTI-SLIP:** DECK PLANKS SHALL BE COATED WITH AMERICAN SAFETY TECHNOLOGIES AS-175 OR SUITABLE REPLACEMENT WITH OWNERS REPRESENTATIVE APPROVAL
- **BUMPERS:** BUMPERS SHALL BE EASTERN RED CEDAR STRIPPED CLEAN OF ALL BARK AND SAP WOOD OR COMPARABLE NATURALLY ROT RESISTANT WOOD.
- **FOOTERS:** FOOTERS SHALL BE DRIVEN OR HELICAL PILES

ROCK ARMOR: THE MAJORITY OF STONES SHOULD BE AT A MINIMUM 18"W X 6"L X 4"T. LARGER STONES ARE ENCOURAGED TO BE USED.

- REMOVE ALL ORGANIC MATTER FROM AREA OF ARMORING TO A DEPTH OF THICKEST STONE
- ARMORING TO EXTEND AT LEAST 6' BEYOND INDICATIONS OF SURFACE FLOW OR TO EXTENT OF SATURATED SOILS.
- ANCHOR STONES ARE PLACED AT EACH TERMINUS, SPAN THE ENTIRE TRAIL TREAD AND EXTEND DEEP INTO THE MINERAL SOIL (2/3 OF ROCK MUST BE BURIED).
- STEPPER STONES, LARGE FLAT STONES, ARE PLACED DIRECTLY ON MINERAL SOIL (OR AN AGGREGATE FOUNDATION).
- STEPPER STONES ARE SET AT-GRADE TO ELIMINATE ANY POTENTIAL OBSTRUCTION TO NORMAL WATER FLOW.
- EACH STONE MUST HAVE 3 POINTS OF CONTACT WITH OTHER STONES AND BE LOCKED INTO PLACE.
- PORE SPACES BETWEEN STONES WILL BE FILLED WITH SMALLER CHOCK STONES OR CRUSHED ROCK.
- WHEN COMPLETE, NO STONE IN STRUCTURE SHOULD MOVE IN ANY DIRECTION WHEN SIGNIFICANT PRESSURE IS APPLIED.

*DETAILS SHOWN FOR REFERENCE ONLY. CONTRACTOR TO ADJUST AS FIELD CONDITIONS ALLOW AND TO PROVIDE SHOP DRAWINGS TO BE APPROVED BY OWNERS REPRESENTATIVE

DATE
02/17/2022

REVISION

- 1: INITIAL RELEASE 02/11/22
- 2: UPDATE SKILLS PARK LOCATION, ADDITION DETAILS 02/17/22
- 3: UPDATED HIGH GROUND LOOP ALIGNMENT 03/10/22
- 4: UPDATED TOTAL LN FT TO 31,700 FROM 32,560 03/15/2022



DESIGN AND BUILD
CONSERVATION THROUGH RECREATION
Chapel Hill NC • Brevard NC • Salt Lake City UT
11312 US Hwy 15 S01 N. #107185
Chapel Hill, NC 27517

WILDWOOD PARK
MOUNTAIN BIKE TRAILS

TRAIL DETAILS

Sheet Number

7

*DETAILS SHOWN FOR REFERENCE ONLY. CONTRACTOR TO ADJUST AS FIELD CONDITIONS ALLOW AND TO PROVIDE SHOP DRAWINGS TO BE APPROVED BY OWNERS REPRESENTATIVE

TRAIL ARCH

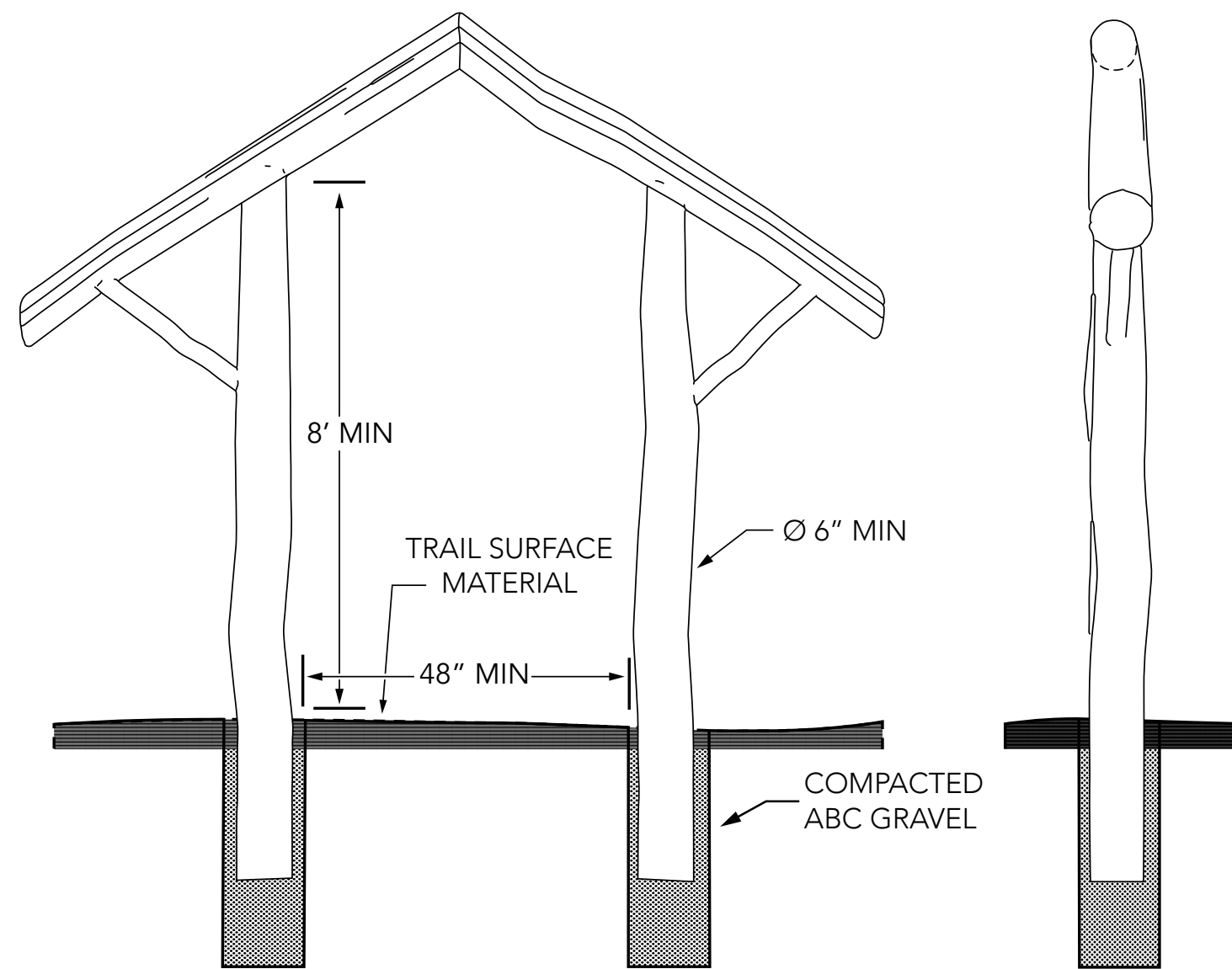
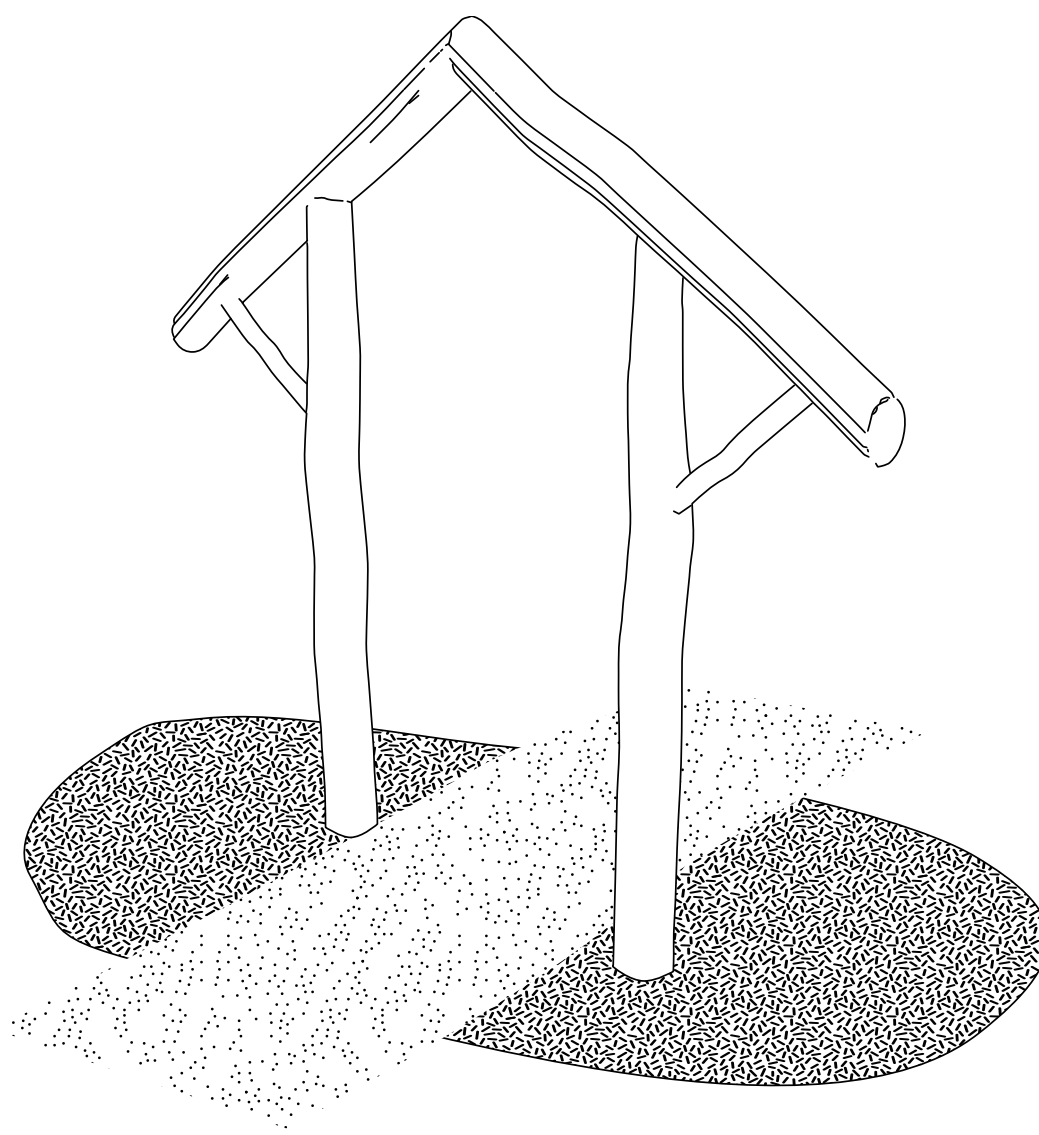

LIVE EDGE CEDAR BENCH

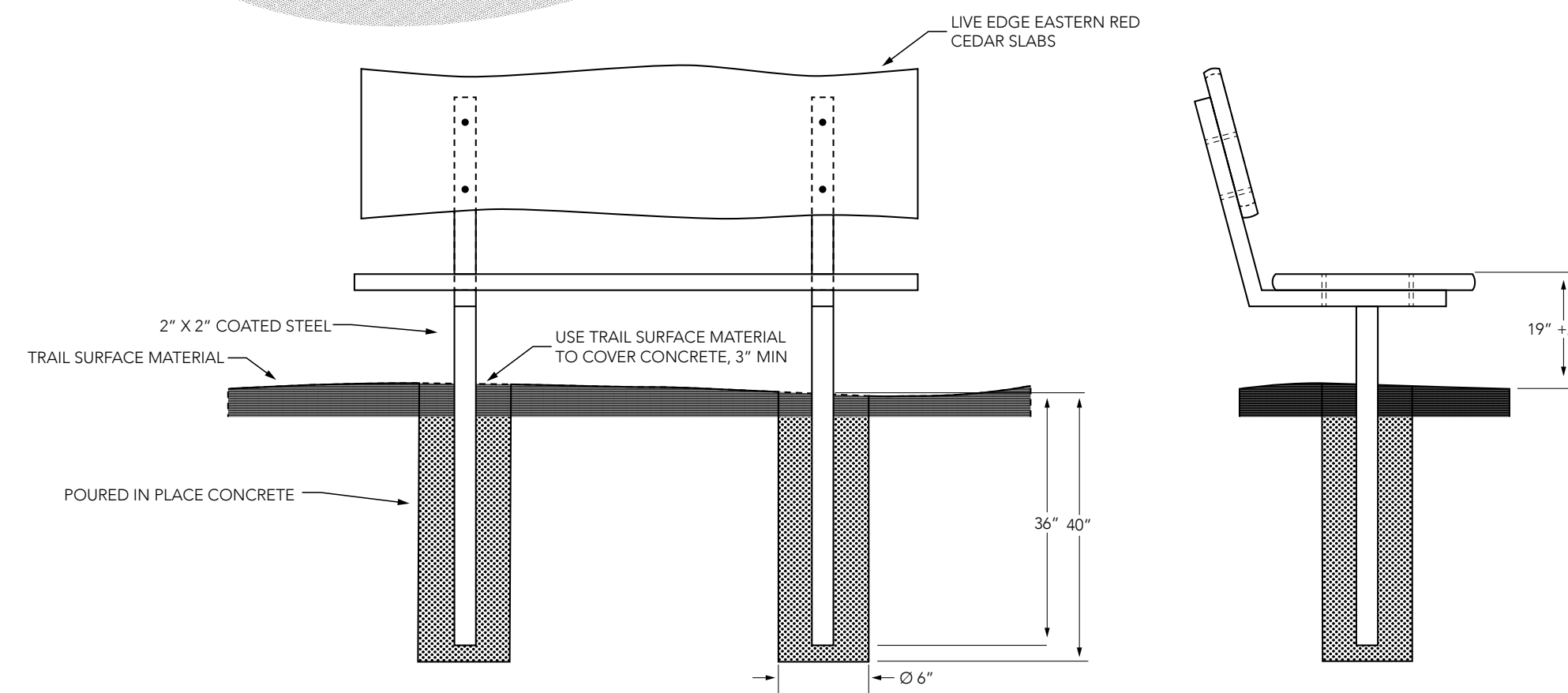
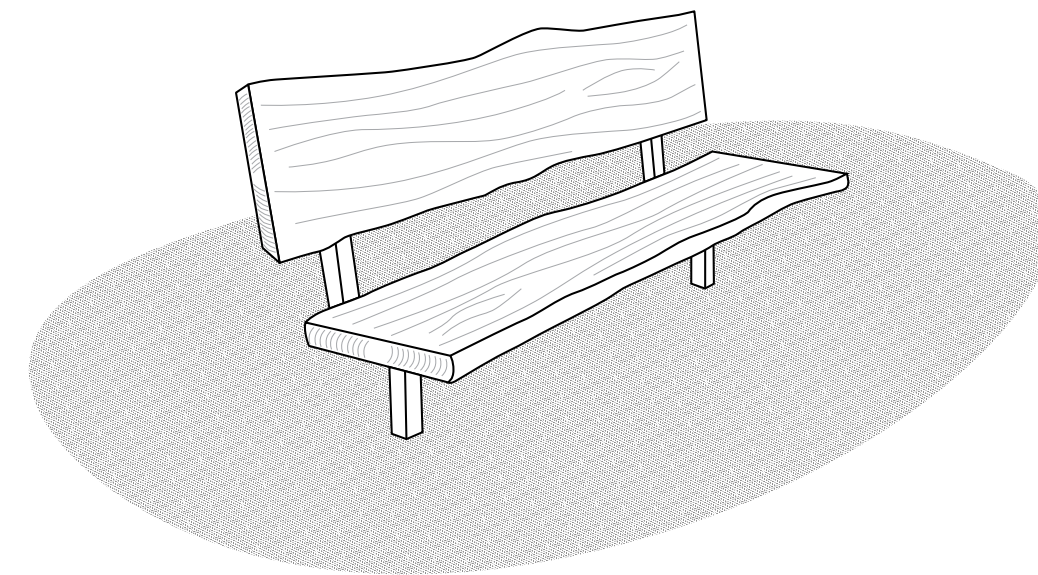

KIOSK

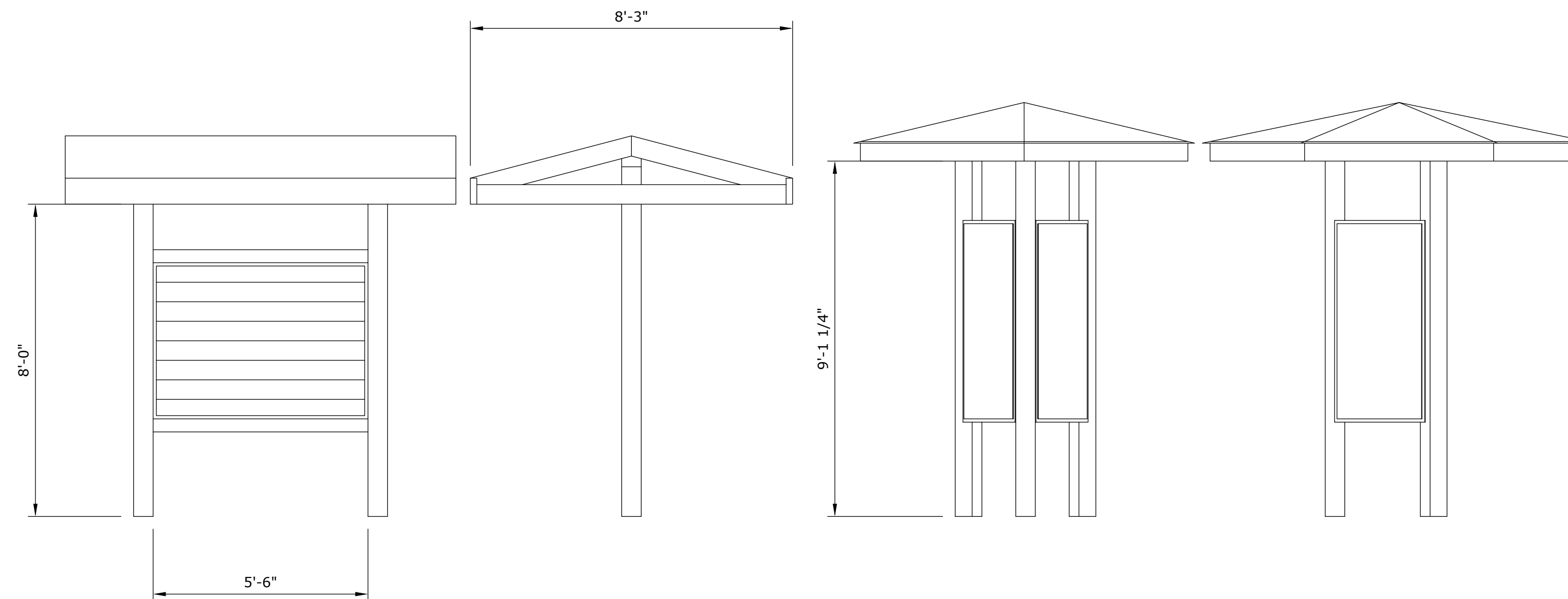

WAYFINDING

GENERAL NOTES:

WAYFINDING PACKAGE: A COHESIVE WAYFINDING PACKAGE SHALL BE DESIGNED AND INSTALLED IN THE WILDWOOD PARK TRAIL NETWORK

- **KIOSK:** KIOSK SHOULD CONTAIN OVERALL TRAIL MAP AND COPY OF PARK RULES AND REGULATIONS
- **CARSONITE POSTS:** CARSONITE POSTS SHALL BE USED FOR WAYFINDING AND DIRECTION OF TRAIL TRAVEL
- **STICKER PACK:** A GRAPHIC STICKER PACK MAYBE UTILIZED ON CARSONITE POSTS

*FOR REFERENCE ONLY. CONTRACTOR TO PROVIDE FINAL GRAPHICS TO BE APPROVED BY OWNER

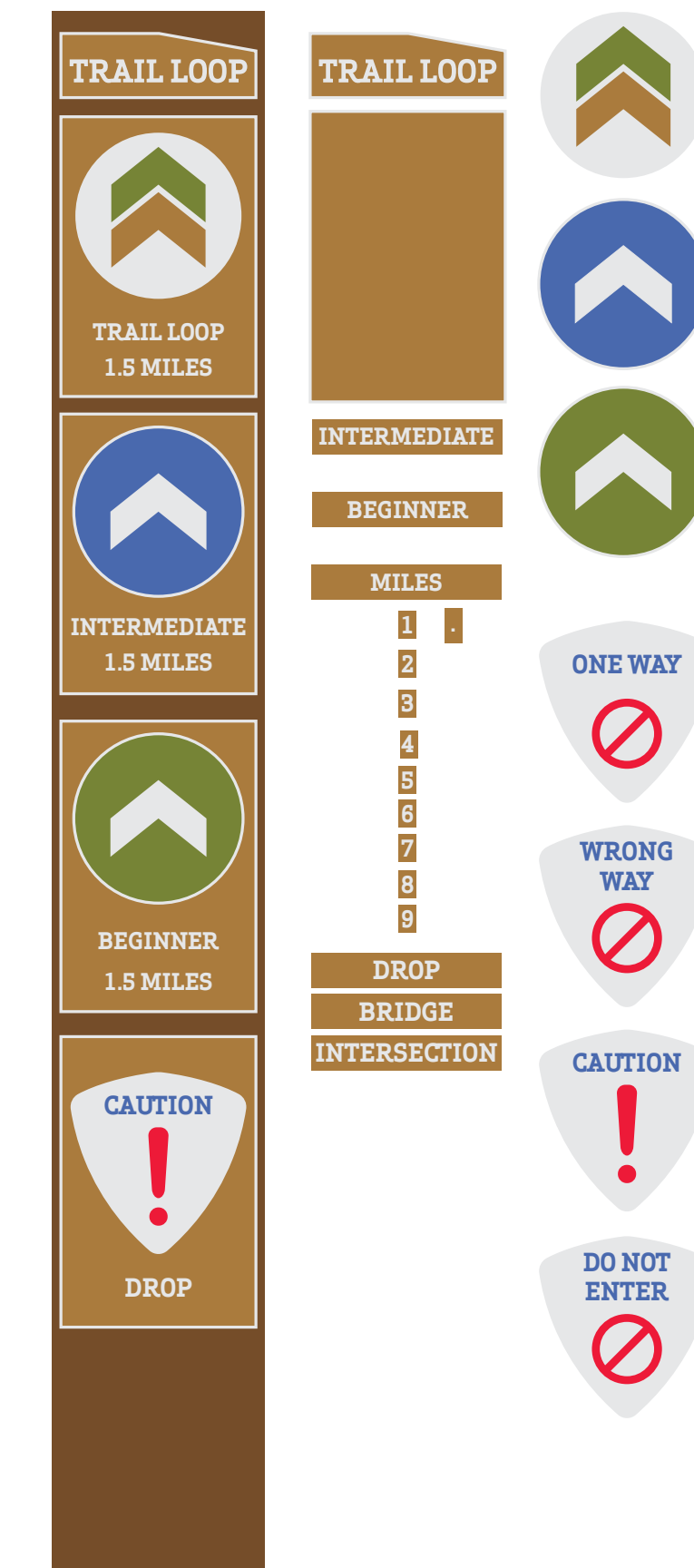

DATE	02/17/2022
	REVISION
1: INITIAL RELEASE 02/11/22 2: UPDATE SKILLS PARK LOCATION, ADDITION DETAILS 02/17/22 3: UPDATED HIGH GROUND LOOP ALIGNMENT 03/10/22 4: UPDATED TOTAL LN FT TO 31,700 FROM 32,560 03/15/2022	



WILDWOOD PARK MOUNTAIN BIKE TRAILS TRAIL DETAILS

Sheet Number

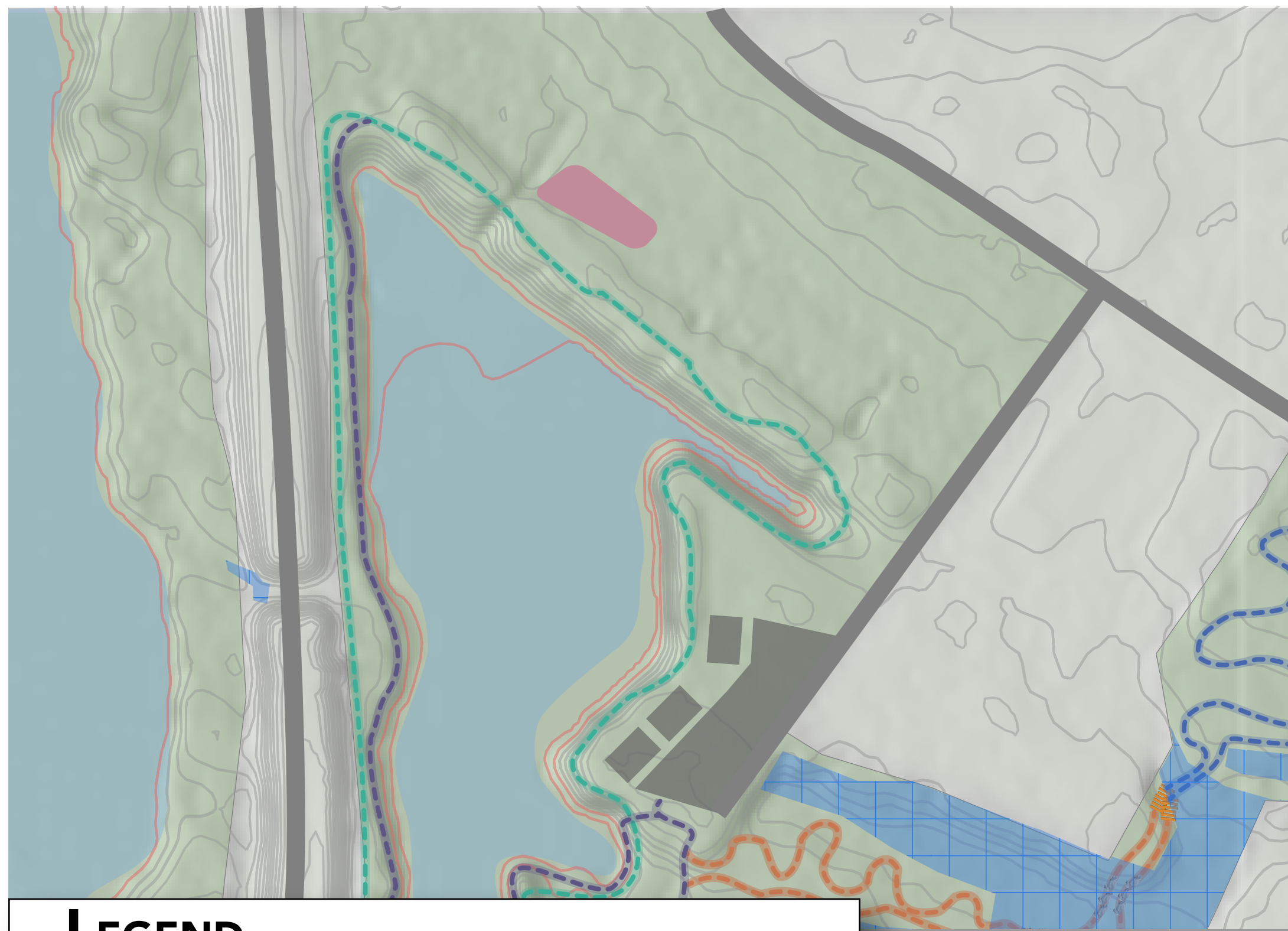

LEGEND

- WILDWOOD HIGH GROUND LOOP
- WILDWOOD LOWLAND LOOP B
- BOARDWALK
- WILDWOOD LOWLAND LOOP A
- WILDWOOD LOWLAND LOOP C
- ROCK ARMORING
- CONTOUR BELOW 6FT
- WILDWOOD GREENWAY
- SKILLS / PUMP TRACK
- CONTOUR ABOVE 6FT
- WILDWOOD EAST LOOP
- DELINEATED WETLANDS

WILDWOOD PARK PUMPTRACK ESTIMATED QUANTITIES

	Description	Est Quantity	Unit
1	Site Preparation + Drainage	1	LS
2	70/30 Clay/Sand Fill Material	875	CU YD
3	Road Base Fill	80	CU YD
4	Paved Riding Surface	3,958	SQ FT

WILDWOOD PARK SKILLS PARK ESTIMATED QUANTITIES

	Description	Est Quantity	Unit
1	40' Shipping Container with flood vents, anchors	2	LS
2	20' Shipping Container with flood vents, anchors	1	LS
3	70/30 Clay/Sand Fill Material	1200	CU YD
4	Start area, container surfacing, handrails, drop, access ramp w/ retaining wall	1	LS
5	Advance line constructed take off ramp, steel substructure rough sawn cedar finish, 6' tall	4	LS
6	Intermediate line constructed take off ramp, steel substructure rough sawn cedar finish, 4' tall	4	LS
7	Beginner line constructed take off ramp, steel substructure rough sawn cedar finish, 3' tall	4	LS

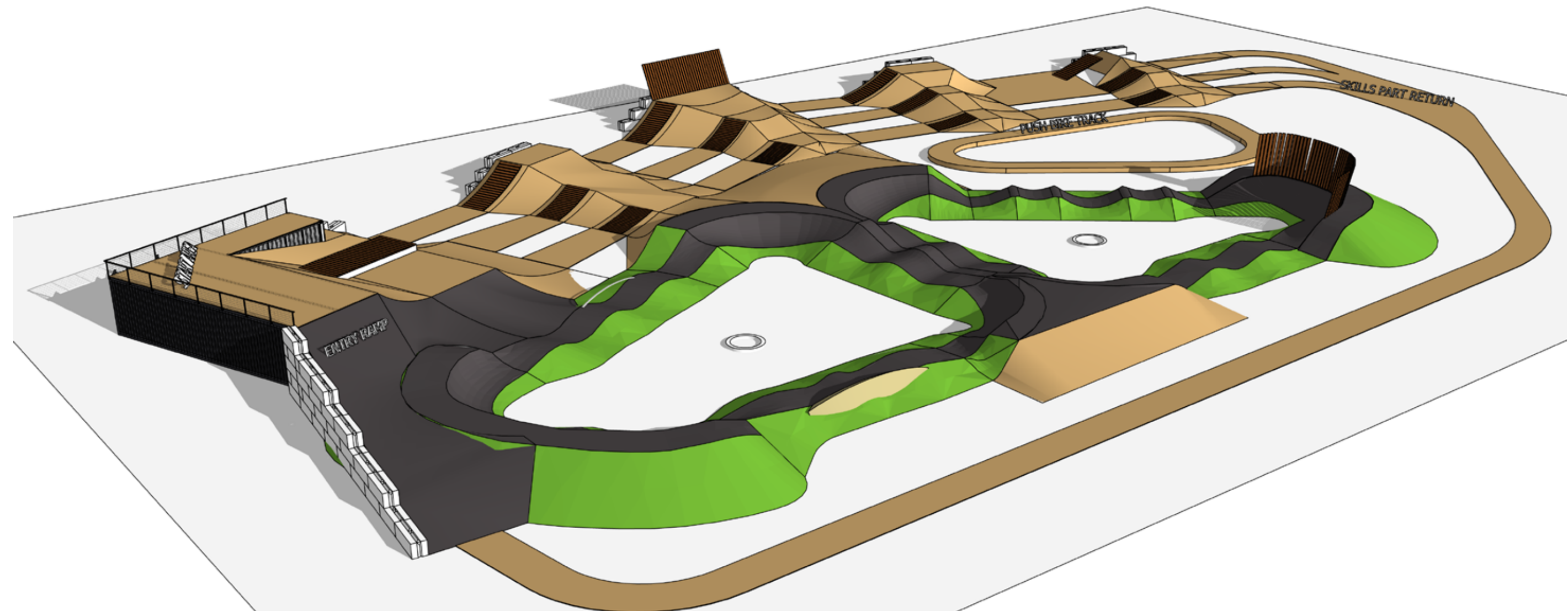
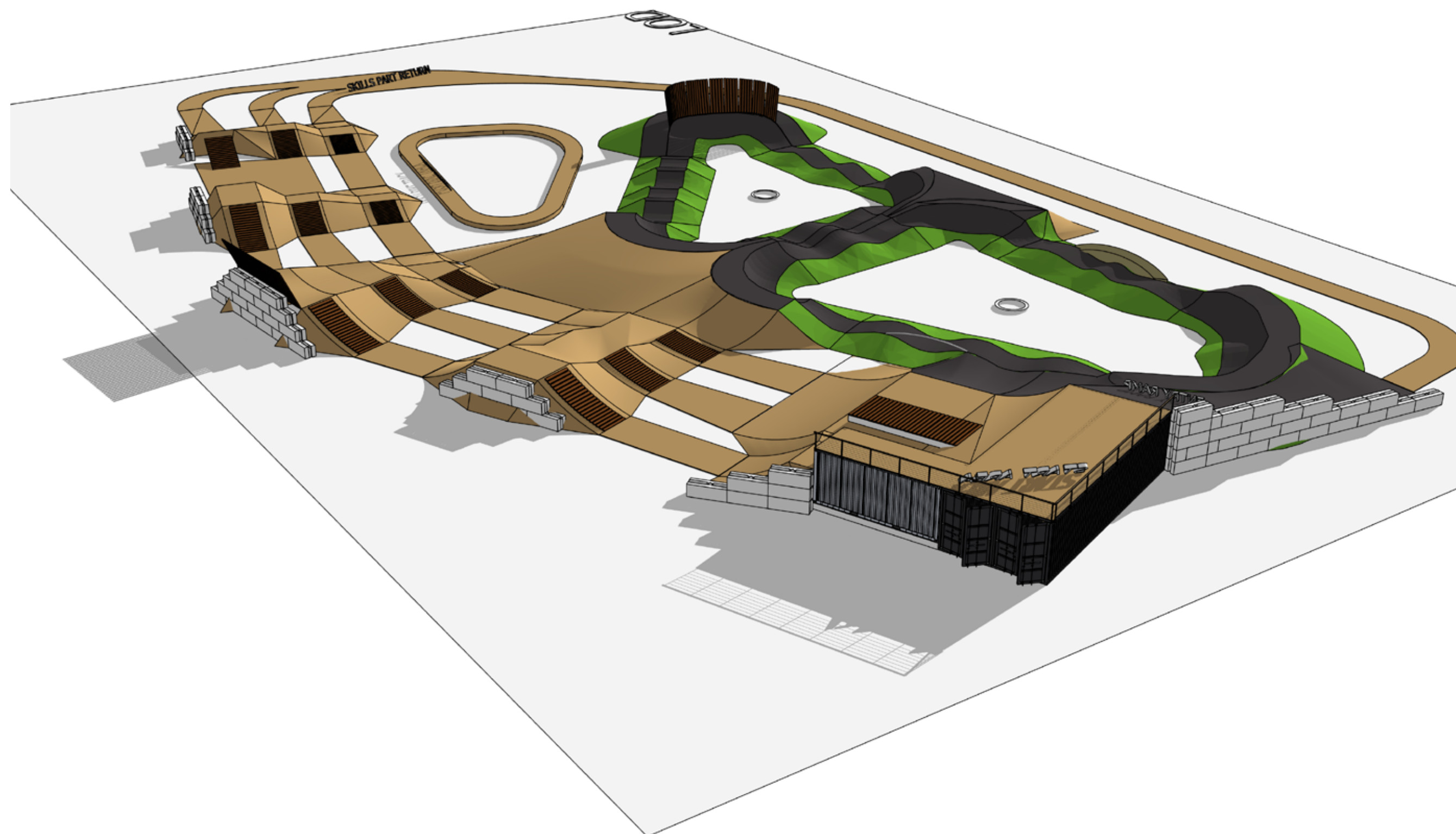
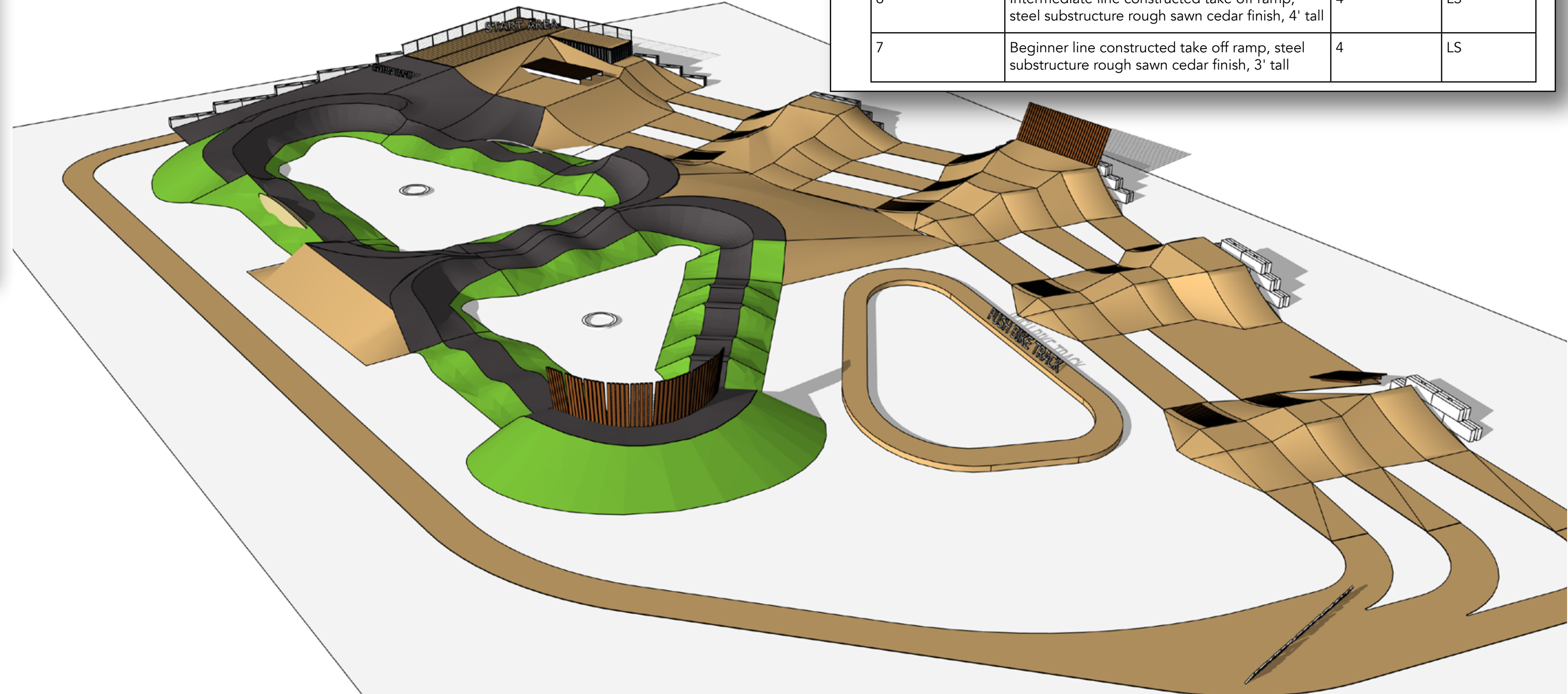

DATE
02/17/2022

REVISION

- 1: INITIAL RELEASE 02/11/22
- 2: UPDATE SKILLS PARK LOCATION, ADDITION DETAILS 02/17/22
- 3: UPDATED HIGH GROUND LOOP ALIGNMENT 03/10/22
- 4: UPDATED TOTAL LN FT TO 31,700 FROM 32,560 03/15/2022



CONSERVATION THROUGH RECREATION
Chapel Hill NC • Brevard NC • Salt Lake City, UT
11312 US Hwy 15 501 N. #107185
Chapel Hill, NC 27517

WILDWOOD PARK
MOUNTAIN BIKE TRAILS
SKILLS PARK / PUMP TRACK

Sheet Number

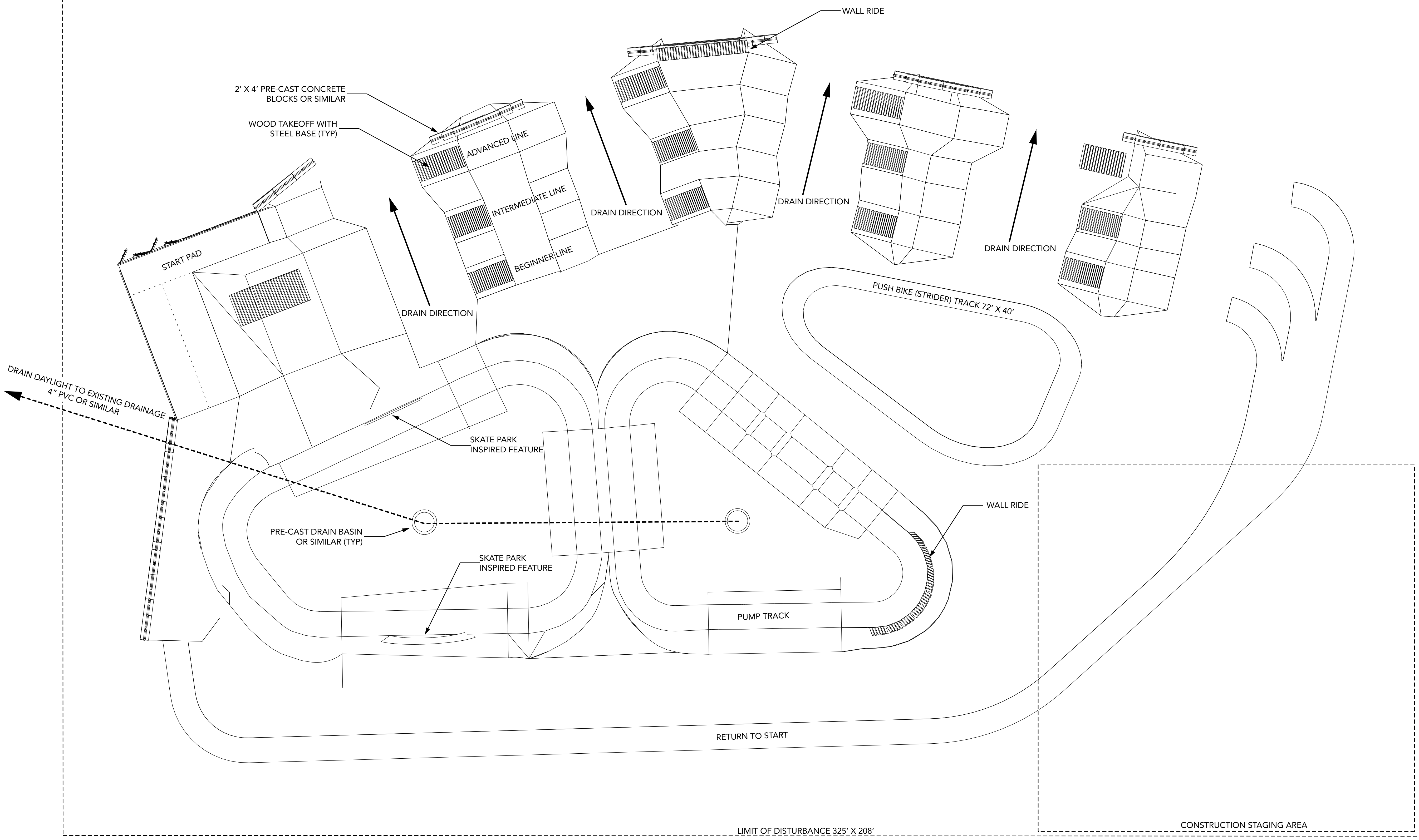

DATE	REVISION
02/17/2022	
	1: INITIAL RELEASE 02/11/22
	2: UPDATE SKILLS PARK LOCATION, ADDITION DETAILS 02/17/22
	3: UPDATED HIGH GROUND LOOP ALIGNMENT 03/10/22
	4: UPDATED TOTAL LN FT TO 31,700 FROM 32,560 03/15/2022

Nature Trails
DESIGN AND BUILD

CONSERVATION THROUGH RECREATION
Chapel Hill NC • Brevard NC • Salt Lake City UT
11312 US Hwy 15 S01 N. #107185
Chapel Hill, NC 27517

**WILDWOOD PARK
MOUNTAIN BIKE TRAILS
SKILLS PARK / PUMP TRACK
SITE LAYOUT AND DRAINAGE**

Sheet Number

10

 PAVED RIDING SURFACE

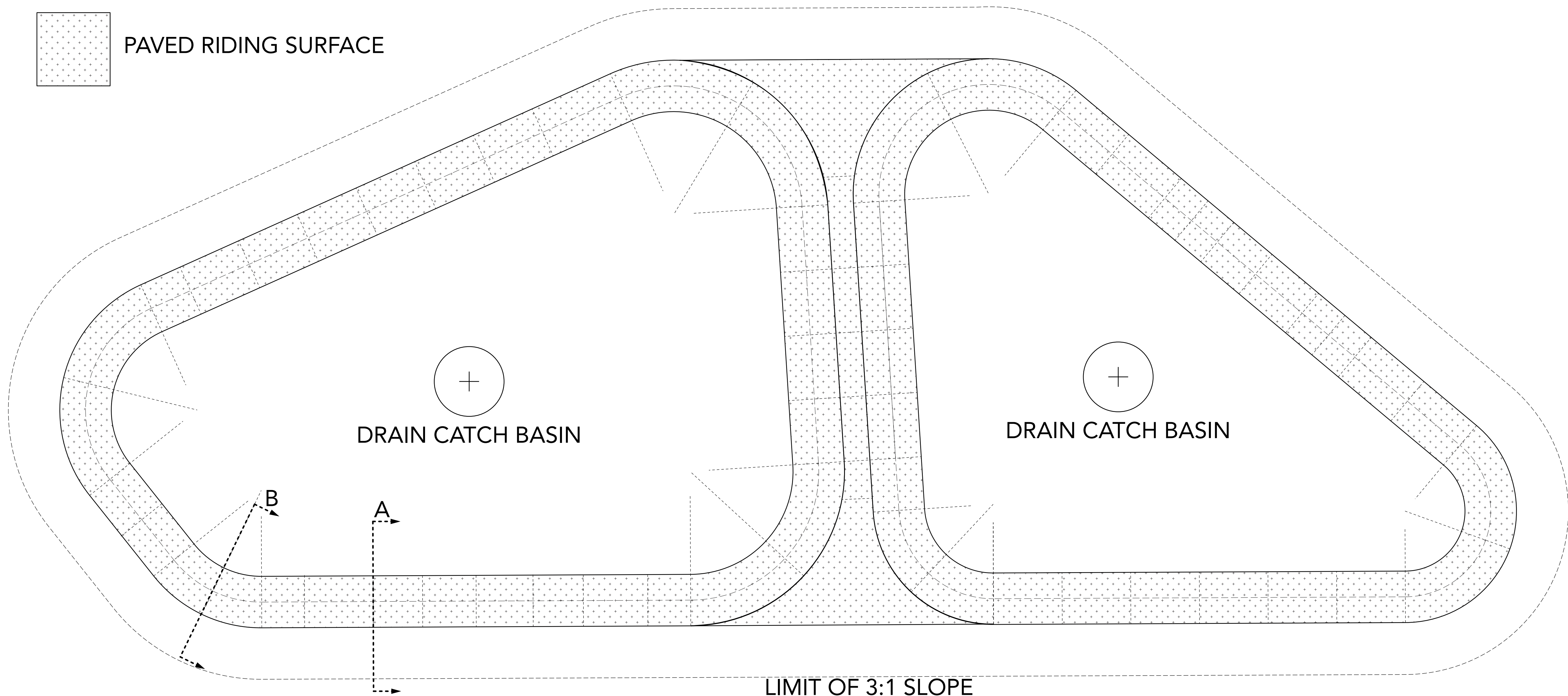

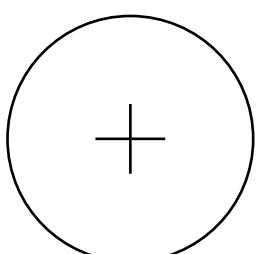

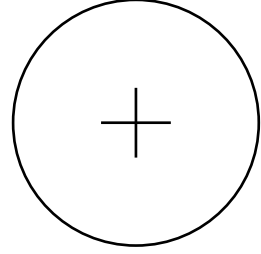
DRAIN CATCH BASIN

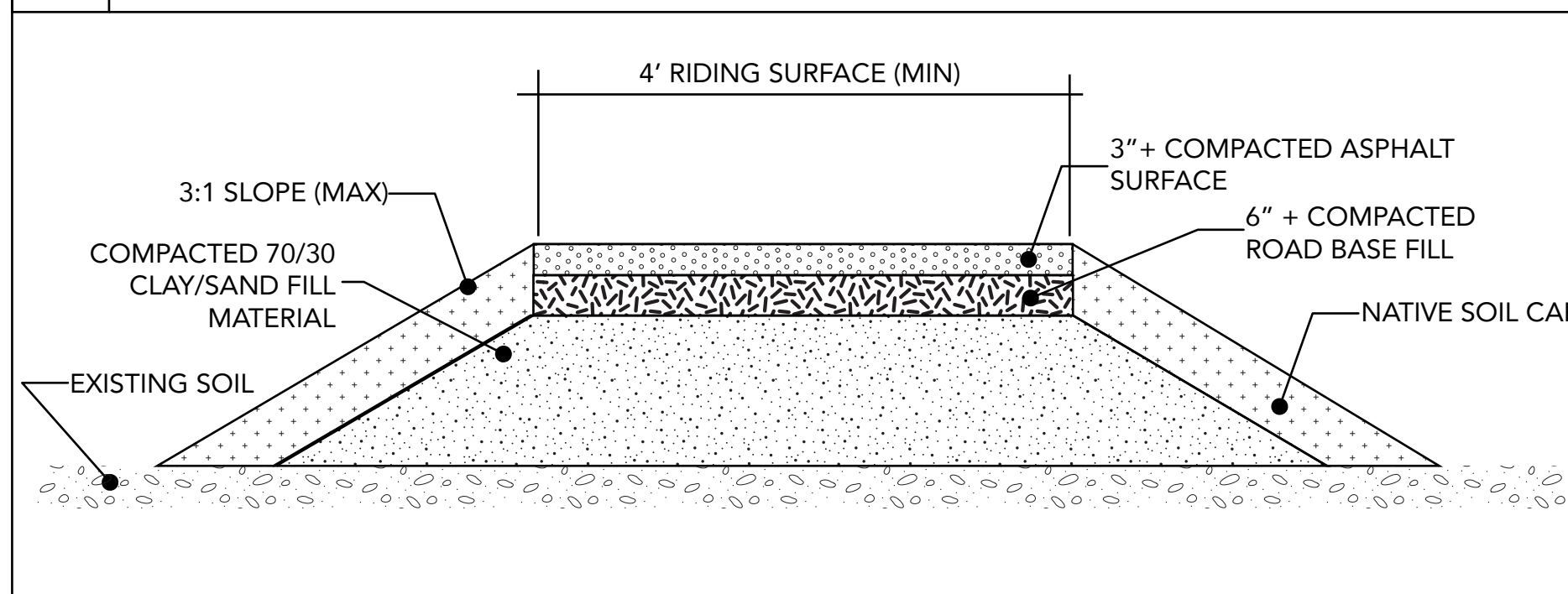

DRAIN CATCH BASIN

LIMIT OF 3:1 SLOPE

A TYPICAL RIDE SURFACE CROSS-SECTION

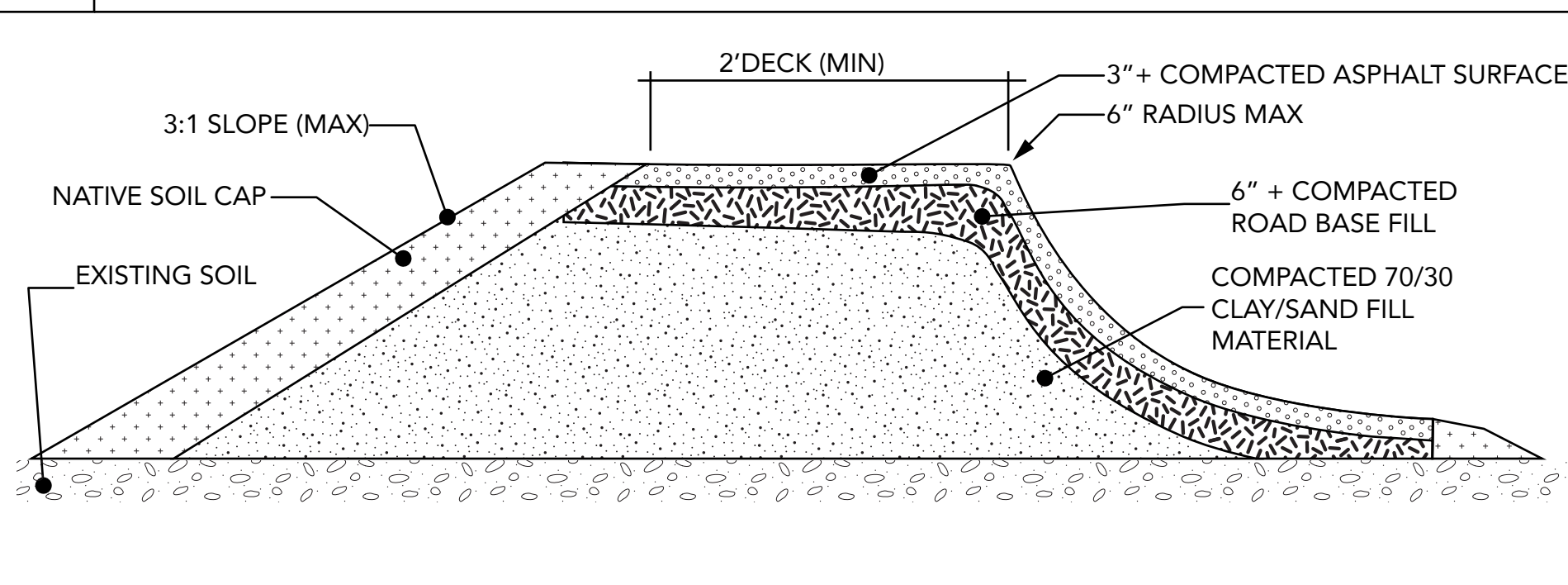

B TYPICAL BERM SURFACE CROSS-SECTION



DATE	REVISION
02/17/2022	
	1: INITIAL RELEASE 02/11/22
	2: UPDATE SKILLS PARK LOCATION, ADDITION DETAILS 02/17/22
	3: UPDATED HIGH GROUND LOOP ALIGNMENT 03/10/22
	4: UPDATED TOTAL LN FT TO 31,700 FROM 32,560 03/15/2022



DESIGN AND BUILD

CONSERVATION THROUGH RECREATION
Chapel Hill NC • Brevard NC • Salt Lake City UT
11312 US Hwy 15 S01 N. #107185
Chapel Hill, NC 27517

WILDWOOD PARK
MOUNTAIN BIKE TRAILS
SKILLS PARK / PUMP TRACK

Sheet Number

11

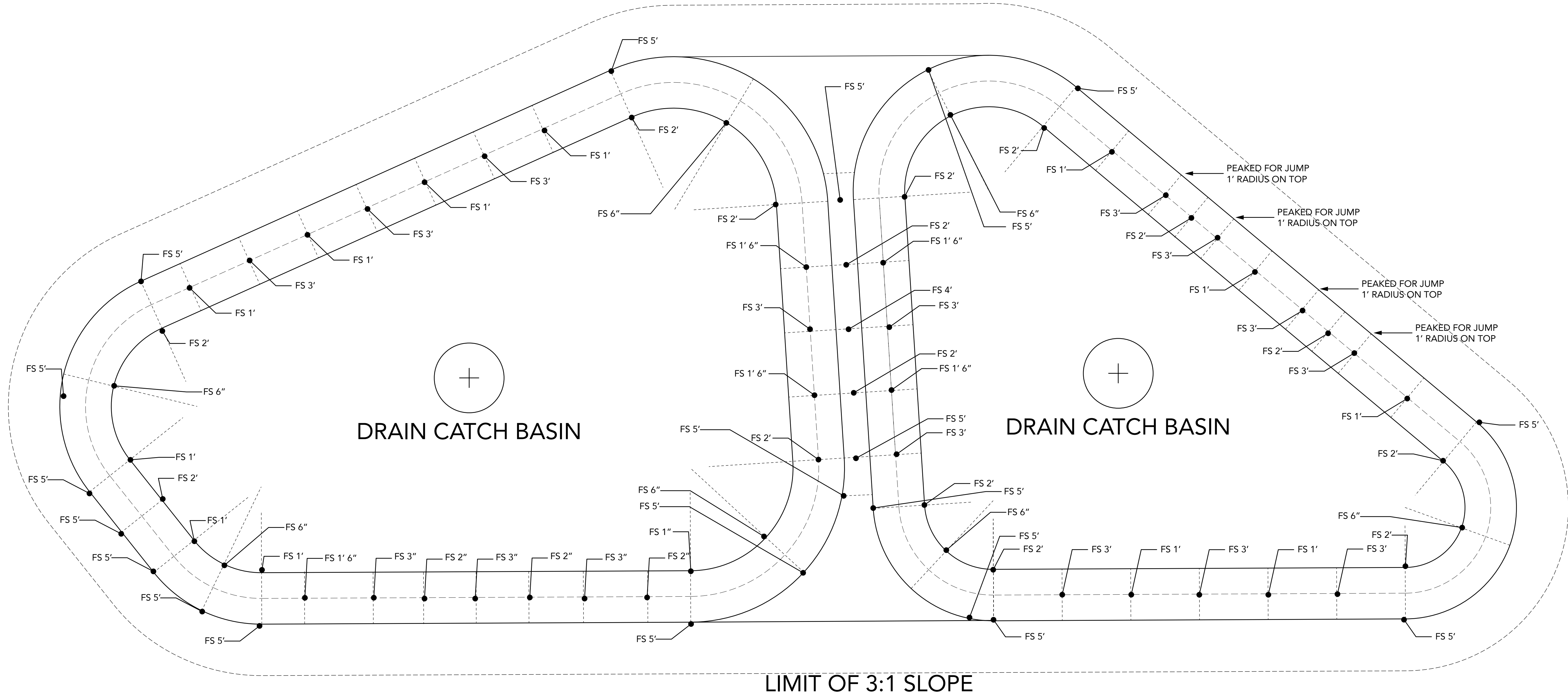

FS : FINISHED SURFACE
FS : 0" = SURFACE GRADE

DATE	REVISION
02/17/2022	

1: INITIAL RELEASE 02/11/22
2: UPDATE SKILLS PARK LOCATION, ADDITION DETAILS 02/17/22
3: UPDATED HIGH GROUND LOOP ALIGNMENT 03/10/22
4: UPDATED TOTAL LN FT TO 31,700 FROM 32,560 03/15/2022

DESIGN AND BUILD
CONSERVATION THROUGH RECREATION
Chapel Hill NC • Brevard NC • Salt Lake City UT
11312 US Hwy 15 S01 N, #107185
Chapel Hill, NC 27517

**WILDWOOD PARK
MOUNTAIN BIKE TRAILS
SKILLS PARK / PUMP TRACK
ELEVATIONS**

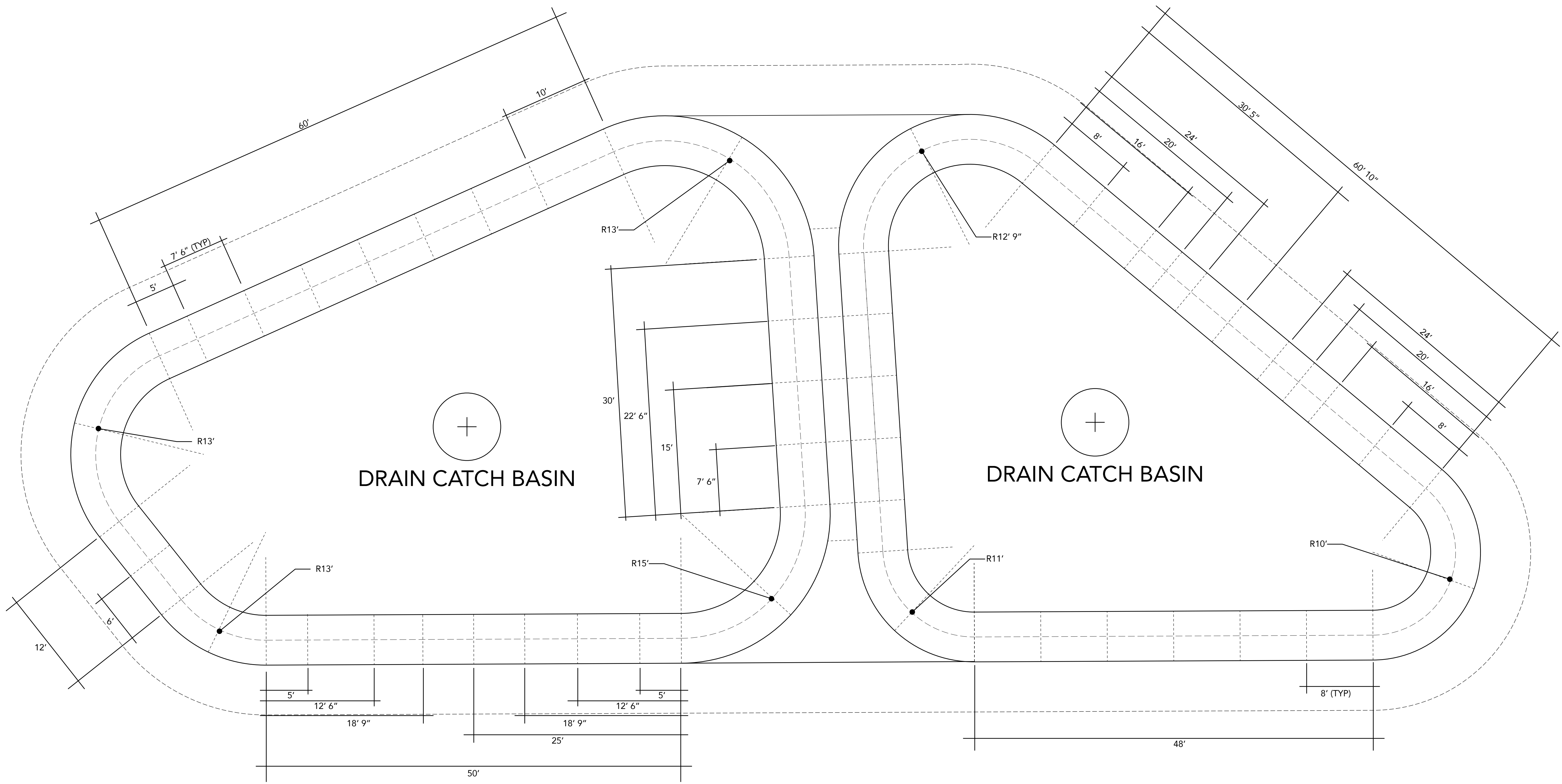

DATE	REVISION
02/17/2022	1: INITIAL RELEASE 02/11/22 2: UPDATE SKILLS PARK LOCATION, ADDITION DETAILS 02/17/22 3: UPDATED HIGH GROUND LOOP ALIGNMENT 03/10/22 4: UPDATED TOTAL LN FT TO 31,700 FROM 32,560 03/15/2022



DESIGN AND BUILD
CONSERVATION THROUGH RECREATION
Chapel Hill NC • Brevard NC • Salt Lake City UT
11312 US Hwy 15 S01 N, #107185
Chapel Hill, NC 27517

WILDWOOD PARK
MOUNTAIN BIKE TRAILS
SKILLS PARK / PUMP TRACK
ROLLER AND BERM DETAILS